



Prolunga
- filettatura R, filettatura Rp

Fornitura
Poligono interno

Modello 3525

articolo 357 191

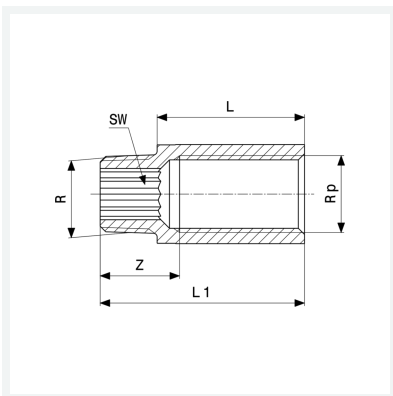

Caratteristiche

Filettatura maschio conica	R	1
Filettatura interna cilindrica	Rp	1
Lunghezza	L	30
Dimensione	Z	30 mm
Lunghezza 1	L1	50 mm
Diametro chiave	SW	22 mm
Peso	168,1 g	
Volume	155,4 cm ³	
Materiale	bronzo o bronzo al silicio	