

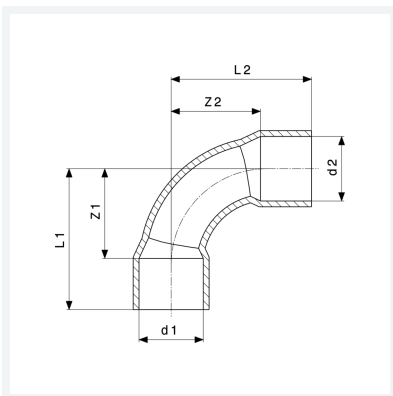

Gomito a 90°
- estremità a saldare femmina
Modello 95090

articolo 103 132



Caratteristiche

Diametro esterno del tubo 1	d1	10
Diametro esterno del tubo 2	d2	10
Dimensione 1	Z1	14 mm
Dimensione 2	Z2	14 mm
Lunghezza 1	L1	22 mm
Lunghezza 2	L2	22 mm
Peso	10,02 g	
Volume	12,432 cm ³	
Materiale	rame	