



## Gomito a 90°

- estremità a saldare femmina, estremità maschio

**Modello 95092**

**articolo 102 067**

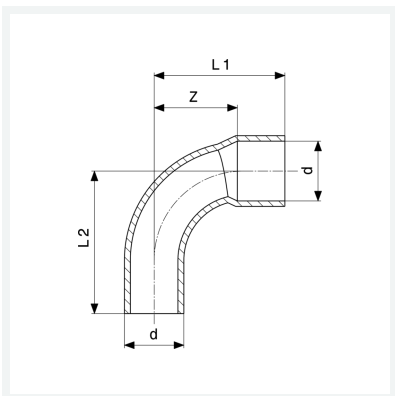

## Caratteristiche

Diametro esterno del tubo	d	28
Dimensione	Z	25 mm
Lunghezza 1	L1	44 mm
Lunghezza 2	L2	47 mm
Peso	82,8 g	
Volume	124,3 cm <sup>3</sup>	
Materiale	rame	