

# SERBATOI POLIETILENE CILINDRICI INTERRO

SERBATOI IN POLIETILENE CILINDRICI DA INTERRO



## Informazioni tecniche

I Serbatoi in polietilene da interro sono destinati allo stoccaggio di acqua a pressione atmosferica.

Le principali caratteristiche sono:

- Polietilene lineare ad alta densità
- Leggeri e facili da movimentare
- Resistenti agli urti e agli agenti chimici
- Resistenti agli sbalzi di temperatura (-40°C + 60°C)
- Alta resistenza fotometrica ai raggi UV
- Inattaccabili da alghe
- Facilmente lavabili con normali detergenti

## Impiego

- Stoccaggio di acqua a pressione atmosferica (**COLORE NERO**).
- Stoccaggio di acqua idonea al consumo umano nella versione in polietilene alimentare, a norma del D.M. n. 174, del 06/04/04 (**COLORE GRIGIO**).

## Materiale

Polietilene lineare ad alta densità.

## Installazione, manutenzione e carrabilità

### Garanzia: 2 anni

Vedi condizioni generali di vendita e norme per una corretta installazione.



MODELLO BREVETTATO

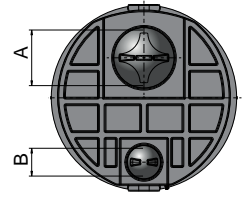
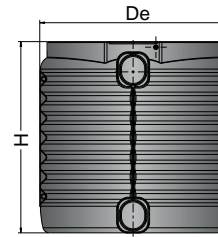

Modello	SERB. POLIET. INTERRO VT	SERB. POLIET. INTERRO VT ALIMENTARE	De	H	A	B
	CODICE	CODICE	[mm]			
<b>750</b>	3500262010507	3500262010527	1100	1160	410	210
<b>1120</b>	3500262010508	3500262010528	1100	1610	410	210
<b>1680</b>	3500262010511	3500262010531	1400	1570	410	210
<b>2240</b>	3500262010514	3500262010534	1400	2015	410	210

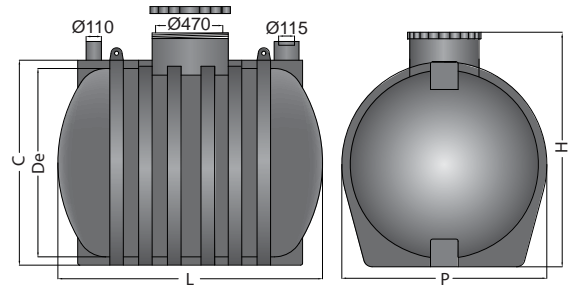

Modello	SERB. POLIET. INTERRO OR	SERB. POLIET. INTERRO OR ALIMENTARE	De	H	P	L	C
	CODICE	CODICE	[mm]				
<b>1500</b>	3500261010510	3500261012110	1200	1445	1310	1570	1250
<b>Prolunga</b>	5006170710010	5006170710014	H: 300 mm				

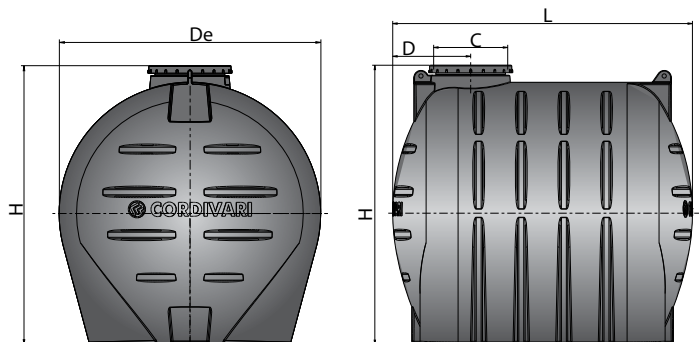

Modello	SERB. POLIET. INTERRO OR	SERB. POLIET. INTERRO OR ALIMENTARE	De	H	L	C	D
	CODICE	CODICE	[mm]				
<b>3000</b>	3500261010112	3500261012122	1500	1744	1940	470	511
<b>5000</b>	3500261010114	3500261012124	1843	2087	2110	470	549
<b>Prolunga</b>	5006170710010	5006170710014	H: 300 mm				

# SERBATOI POLIETILENE CILINDRICI INTERRO

SERBATOI IN POLIETILENE CILINDRICI DA INTERRO



Mod. 10000

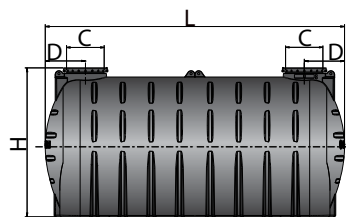

BREVETTATO



Mod. 15000

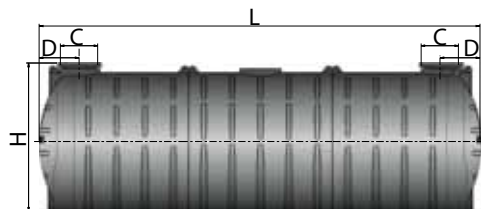

Mod. 20000

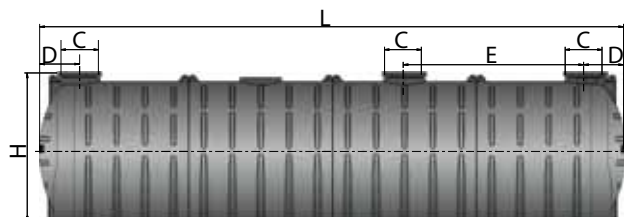

Mod. 25000

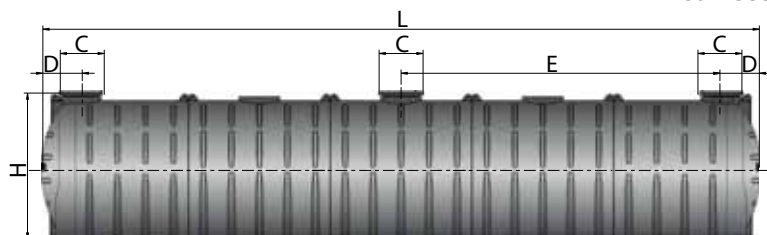

Mod. 30000

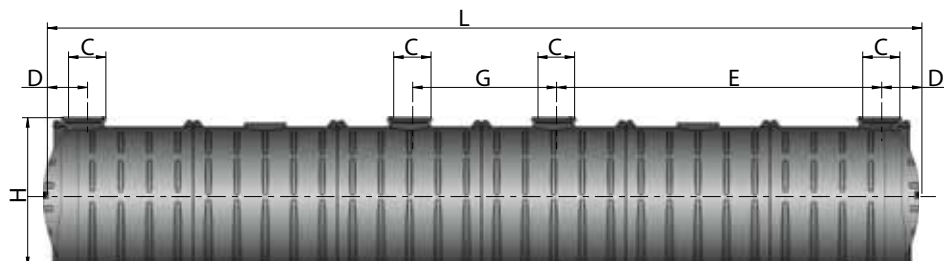

Mod. 35000

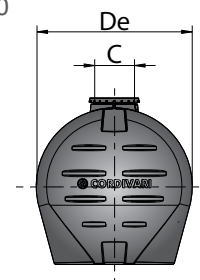
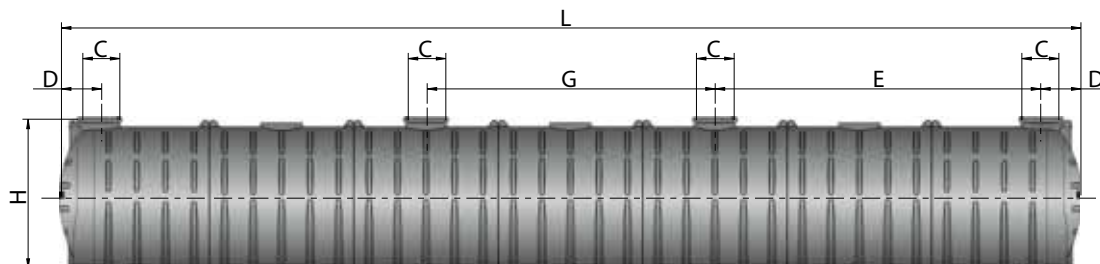

## ACCESSORI



PROLUNGA PER SERBATOI DA INTERRO

CODICE	Ø Esterno [mm]	Altezza [mm]
5006170710010	600	300

PROLUNGA PER SERBATOI DA INTERRO ALIMENTARE

CODICE	Ø Esterno [mm]	Altezza [mm]
5006170710014	600	300

SERBATOI STOCCAGGIO ACQUA  
INOX - ZINCATI - POLIETILENE - ANTINCENDIO

Modello	SERB. POLIET. INTERRO OR	SERB. POLIET. INTERRO OR ALIMENTARE	De	H	L	C	D	E	G	N° Passi d'uomo
CODICE			[mm]							
<b>10000</b>	3500261010520	3500262010535	1843	2087	3950	470	549	-	-	2
<b>15000</b>	3500261010525	3500262010536	1843	2087	5850	470	549	-	-	2
<b>20000</b>	3500261010530	3500262010537	1843	2087	7750	470	549	2394	-	3
<b>25000</b>	3500261010535	3500262010538	1843	2087	9650	470	549	4294	-	3
<b>30000</b>	3500261010540	3500262010539	1843	2087	11550	470	549	4294	1900	4
<b>35000</b>	3500261010545	3500262010540	1843	2087	13450	470	549	4294	3800	4
<b>Prolunga</b>	5006170710010	5006170710014						H: 300 mm		