

zehnder

always the
best climate

Zehnder Charleston





Zehnder Charleston







Zehnder Charleston

Zehnder Charleston, l'originale tra i radiatori tubolari.

L'attuale famiglia di prodotti comprende, oltre alla versione standard, le soluzioni Zehnder Charleston Retrofit ed EasyAccess, adatte per ristrutturare facilmente grazie agli interassi adeguati alle sostituzioni. Particolarmente interessanti la versione orizzontale Charleston Turned, quella elettrica e, su richiesta, la versione Clinic indicata per i suoi particolari requisiti igienici.



Zehnder Charleston

Made in
Germany



DATI TECNICI

- Radiatore in acciaio con tubi tondi da **25 mm**
- Testata in lamiera d'acciaio
- Lunghezza del singolo elemento **46 mm**
- Pressione max di esercizio: **10,0 bar**
- Temperatura max di esercizio: **110°C**
- Verniciatura di fondo e verniciatura a polvere secondo la normativa DIN 5590
- Certificazione EN442, registrazione CE

POSSIBILITÀ SU MISURA

- Grande scelta di allacciamenti, anche con valvola integrata
- Set di montaggio per tutte le varianti d'impiego
- Forme speciali ad angolo, curve ecc

VANTAGGI

- Eleganza classica
- Conforme alle normative antinfortunistiche
- Pulizia con la spazzola in pelo d'agnello Zehnder
- Semplice e a prova di sganciamento: montaggio con Zehnder EasyFix
- Efficienza energetica per l'impiego nei sistemi a bassa temperatura

ACCESSORI IN DOTAZIONE (compresi nella fornitura)

VERSIONE STANDARD (Cod. S001)

- Verniciatura di fondo e verniciatura definitiva RAL 9016
- 4 riduzioni da 1/2"
- Tappo nichelato e sfiato diametro 1/2" compresi nella fornitura
- Imballaggio completo in pellicola termoretraibile e cartone

COMPOSIZIONE CODICE PER ORDINAZIONE RADIATORE SU MISURA

Modello	3	180	012	S001	9016
3180-012-S001-9016	Numero colonne	modello	Numero elementi	Allacciamento	Finitura

SET VALVOLE SUGGERITO

Valvola e detentore a squadra, diametro 1/2", volantino manuale, inserto termostatico M30x1,5 mm con pre-setting 1-7, inclusi 2 dadi 3/4" Eurocono Ø 16,8 mm nella finitura del corpo valvola.

Disegni	Finitura	Codice	Prezzo €	Descrizione
	Cromo	30004250	116,48	Set di valvole tipo A con set raccordi adattatori per tubazione in rame da 12 e 14 mm e in multistrato 16x2 mm
	Bianco RAL 9016	30004881	126,90	

Zehnder Charleston



Zehnder Charleston



Zehnder Charleston

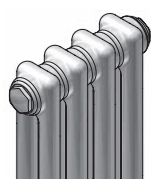

2 COLONNE



3 COLONNE

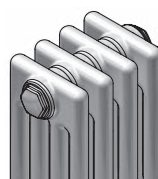

4 COLONNE

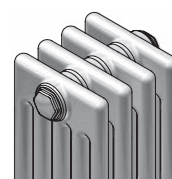

5 COLONNE

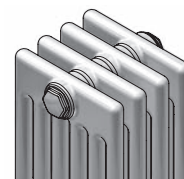

6 COLONNE

Altezza ¹⁾ mm	Interasse mm	Profondità mm				
		62	100	136	173	210
260	194/202	2026	3026	4026	5026	6026
300	234	2030	3030	4030	5030	6030
350	284	2035	3035	4035	5035	6035
400	334	2040	3040	4040	5040	6040
450	384	2045	3045	4045	5045	6045
500	434	2050	3050	4050	5050	6050
550	484	2055	3055	4055	5055	6055
558	500	2056	-	-	-	-
566	500	-	3057	4057	5057	6057
588	530	2059	-	-	-	-
596	530	-	3059	4059	-	-
600	534	2060	3060	4060	5060	6060
628	570	2063	-	-	-	-
636	570	-	3064	4064	-	-
658	600	2066	-	-	-	-
666	600	-	3067	4067	5067	6067
677	619	2068	-	-	-	-
685	619	-	3069	4069	5069	6069
750	684	2075	3075	4075	5075	6075
758	700	2076	-	-	-	-
766	700	-	3077	4077	5077	6077
788	730	2079	-	-	-	-
796	730	-	3079	4079	-	-
858	800	2086	-	-	-	-
866	800	-	3087	4087	5087	6087
877	819	2088	-	-	-	-
885	819	-	3089	4089	5089	6089
900	834	2090	3090	4090	5090	6090
928	870	2093	-	-	-	-
936	870	-	3094	4094	-	-
1000	934	2100	3100	4100	5100	6100
1100	1034	2110	3110	4110	5110	6110
1200	1134	2120	3120	4120	5120	6120
1500	1434	2150	3150	4150	5150	6150
1658	1600	2166	-	-	-	-
1666	1600	-	3167	4167	-	-
1800	1734	2180	3180	4180	5180	6180
1858	1800	2186	-	-	-	-
1866	1800	-	3187	4187	-	-
2000	1934	2200	3200	4200	5200	6200
2058	2000	2206	-	-	-	-
2066	2000	-	3207	4207	-	-
2200	2134	2220	3220	4220	5220	6220
2500	2434	2250	3250	4250	5250	6250
2800	2734	2280	3280	4280	5280	6280
3000	2934	2300	3300	4300	5300	6300

¹⁾ I valori qui menzionati si riferiscono alla cosiddetta altezza nominale, nei radiatori a 2 colonne e talvolta anche a 3 colonne, l'altezza esatta si discosta di alcuni mm, v. "Dati tecnici"; altezze superiori a 3000 mm o altezze intermedie su richiesta.

Lunghezza massima dei radiatori completi (per ogni blocco)

Modello	Altezza mm						
	260 - 600	> 600 - 750	> 750 - 900	> 900 - 1000	> 1000 - 2000	> 2000 - 2500	> 2500 - 3000
2, 3 colonne	64	64	64	64	22	22	22
4 colonne	64	64	64	60	22	22	22
5 colonne	64	64	50	50	22	22	17
6 colonne	64	55	46	42	22	17	14

Classe di sconto: F0

Zehnder Charleston

MODELLO A 2 COLONNE

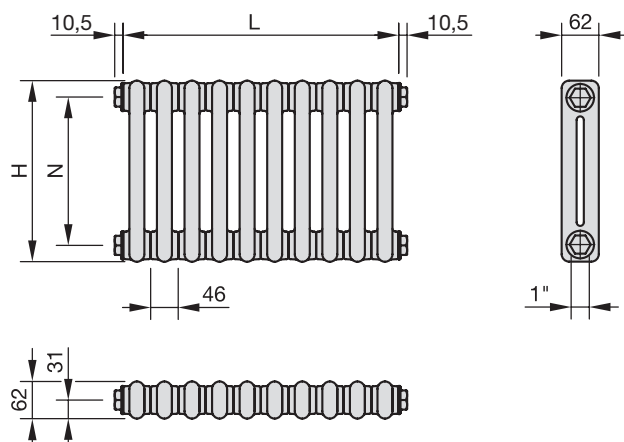

- H = altezza
 L = lunghezza = elementi x 46 mm
 N = interasse = H - 58 mm
 T = profondità
 V = contenuto d'acqua
 M = peso
 s_k = quota di irraggiamento
 q_{ms} = portata nominale
 n = esponente
 Φ_s = potenza termica nominale secondo
 EN 442 (75/65/20 °C) ΔT 50
 Φ = potenza termica con temperature del sistema ΔT 30

Quote in mm

Dati tecnici per elemento

Modello	H mm	N mm	T mm	V dm ³	M kg	s_k %	q_{ms} kg/h	Esp. n	$\Phi_s=\Delta T$ 50 EN442 Watt	$\Phi=\Delta T$ 30 55/45/20 °C Watt	Prezzo ad elemento €
2026	260	202	62	0,3	0,40	25	2,0	1,27	21,1	11,0	20,57
2030	292	234	62	0,4	0,44	25	2,0	1,27	23,6	12,3	21,79
2035	342	284	62	0,4	0,51	24	2,0	1,26	27,5	14,4	21,91
2040	392	334	62	0,4	0,55	25	3,0	1,26	31,2	16,4	21,91
2045	442	384	62	0,5	0,62	24	3,0	1,26	34,9	18,3	22,04
2050	492	434	62	0,5	0,69	23	3,0	1,25	38,4	20,3	22,04
2055	542	484	62	0,6	0,75	23	4,0	1,25	41,9	22,1	22,41
2056	558	500	62	0,6	0,77	23	3,7	1,25	43,0	22,7	22,41
2059	588	530	62	0,6	0,81	23	3,9	1,25	45,0	23,8	22,52
2060	592	534	62	0,6	0,82	23	4,0	1,25	45,3	23,9	22,65
2063	628	570	62	0,7	0,86	22	4,0	1,24	47,7	25,3	23,02
2066	658	600	62	0,7	0,90	22	4,1	1,24	49,7	26,4	23,14
2068	677	619	62	0,7	0,93	23	4,4	1,24	50,9	27,0	23,38
2075	742	684	62	0,7	1,01	22	5,0	1,24	55,0	29,2	24,73
2076	758	700	62	0,7	1,03	22	4,8	1,24	56,0	29,7	25,22
2079	788	730	62	0,7	1,07	22	4,9	1,23	57,8	30,8	25,59
2086	858	800	62	0,8	1,17	22	5,2	1,23	62,0	33,1	26,08
2088	877	819	62	0,8	1,19	22	5,4	1,23	63,1	33,7	27,18
2090	892	834	62	0,8	1,21	22	5,0	1,23	63,9	34,1	27,91
2093	928	870	62	0,8	1,26	22	5,7	1,22	66,0	35,4	28,40
2100	992	934	62	0,9	1,34	22	6,0	1,22	69,5	37,3	29,26
2110	1092	1034	62	1,0	1,47	22	6,0	1,21	74,7	40,3	31,41
2120	1192	1134	62	1,1	1,60	22	7,0	1,30	82,7	42,6	35,30
2150	1492	1434	62	1,3	2,00	23	9,0	1,29	104,0	53,8	46,89
2166	1658	1600	62	1,4	2,22	23	10,0	1,29	115,0	59,5	50,56
2180	1792	1734	62	1,5	2,39	23	11,0	1,29	124,0	64,2	54,46
2186	1858	1800	62	1,5	2,48	23	11,1	1,29	129,0	66,7	57,90
2200	1992	1934	62	1,7	2,65	23	12,0	1,28	138,0	71,8	58,23
2206	2058	2000	62	1,7	2,74	23	12,3	1,28	142,0	73,8	61,91
2220	2192	2134	62	1,9	2,92	23	13,0	1,28	151,0	78,5	70,73
2250	2492	2434	62	2,1	3,31	23	15,0	1,28	171,0	88,9	78,99
2280	2792	2734	62	2,4	3,70	23	16,0	1,27	189,0	98,8	95,60
2300	2992	2934	62	2,5	3,97	23	17,0	1,27	201,0	105,1	101,68

Zehnder Charleston Retrofit: modelli con interassi adatti alle sostituzioni

Prezzo nel colore bianco RAL 9016; Supplemento per i colori della cartella colori: + 25%

Ordini possibili a partire da 2 elementi.

Classe di sconto: F0

Zehnder Charleston

2 COLONNE		Modello	2026	2030	2035	2040	2045	2050	2055	2056	2059
		Interasse (mm)	202	234	284	334	384	434	484	500	530
		Altezza (mm)	260	292	342	392	442	492	542	558	588
Elementi	3	€	61,71	65,37	65,73	65,73	66,12	66,12	67,23	67,23	67,56
Lungh. (mm)	138	Watt	63	71	83	94	105	115	126	129	135
Elementi	4	€	82,28	87,16	87,64	87,64	88,16	88,16	89,64	89,64	90,08
Lungh. (mm)	184	Watt	84	94	110	125	140	154	168	172	180
Elementi	5	€	102,85	108,95	109,55	109,55	110,20	110,20	112,05	112,05	112,60
Lungh. (mm)	230	Watt	106	118	138	156	175	192	210	215	225
Elementi	6	€	123,42	130,74	131,46	131,46	132,24	132,24	134,46	134,46	135,12
Lungh. (mm)	276	Watt	127	142	165	187	209	230	251	258	270
Elementi	7	€	143,99	152,53	153,37	153,37	154,28	154,28	156,87	156,87	157,64
Lungh. (mm)	322	Watt	148	165	193	218	244	269	293	301	315
Elementi	8	€	164,56	174,32	175,28	175,28	176,32	176,32	179,28	179,28	180,16
Lungh. (mm)	368	Watt	169	189	220	250	279	307	335	344	360
Elementi	9	€	185,13	196,11	197,19	197,19	198,36	198,36	201,69	201,69	202,68
Lungh. (mm)	414	Watt	190	212	248	281	314	346	377	387	405
Elementi	10	€	205,70	217,90	219,10	219,10	220,40	220,40	224,10	224,10	225,20
Lungh. (mm)	460	Watt	211	236	275	312	349	384	419	430	450
Elementi	11	€	226,27	239,69	241,01	241,01	242,44	242,44	246,51	246,51	247,72
Lungh. (mm)	506	Watt	232	260	303	343	384	422	461	473	495
Elementi	12	€	246,84	261,48	262,92	262,92	264,48	264,48	268,92	268,92	270,24
Lungh. (mm)	552	Watt	253	283	330	374	419	461	503	516	540
Elementi	13	€	267,41	283,27	284,83	284,83	286,52	286,52	291,33	291,33	292,76
Lungh. (mm)	598	Watt	274	307	358	406	454	499	545	559	585
Elementi	14	€	287,98	305,06	306,74	306,74	308,56	308,56	313,74	313,74	315,28
Lungh. (mm)	644	Watt	295	330	385	437	489	538	587	602	630
Elementi	15	€	308,55	326,85	328,65	328,65	330,60	330,60	336,15	336,15	337,80
Lungh. (mm)	690	Watt	317	354	413	468	524	576	629	645	675
Elementi	16	€	329,12	348,64	350,56	350,56	352,64	352,64	358,56	358,56	360,32
Lungh. (mm)	736	Watt	338	378	440	499	558	614	670	688	720
Elementi	17	€	349,69	370,43	372,47	372,47	374,68	374,68	380,97	380,97	382,84
Lungh. (mm)	782	Watt	359	401	468	530	593	653	712	731	765
Elementi	18	€	370,26	392,22	394,38	394,38	396,72	396,72	403,38	403,38	405,36
Lungh. (mm)	828	Watt	380	425	495	562	628	691	754	774	810
Elementi	19	€	390,83	414,01	416,29	416,29	418,76	418,76	425,79	425,79	427,88
Lungh. (mm)	874	Watt	401	448	523	593	663	730	796	817	855
Elementi	20	€	411,40	435,80	438,20	438,20	440,80	440,80	448,20	448,20	450,40
Lungh. (mm)	920	Watt	422	472	550	624	698	768	838	860	900
Elementi	21	€	431,97	457,59	460,11	460,11	462,84	462,84	470,61	470,61	472,92
Lungh. (mm)	966	Watt	443	496	578	655	733	806	880	903	945
Elementi	22	€	452,54	479,38	482,02	482,02	484,88	484,88	493,02	493,02	495,44
Lungh. (mm)	1012	Watt	464	519	605	686	768	845	922	946	990
Elementi	23	€	473,11	501,17	503,93	503,93	506,92	506,92	515,43	515,43	517,96
Lungh. (mm)	1058	Watt	485	543	633	718	803	883	964	989	1.035
Elementi	24	€	493,68	522,96	525,84	525,84	528,96	528,96	537,84	537,84	540,48
Lungh. (mm)	1104	Watt	506	566	660	749	838	922	1.006	1.032	1.080
Elementi	25	€	514,25	544,75	547,75	547,75	551,00	551,00	560,25	560,25	563,00
Lungh. (mm)	1150	Watt	528	590	688	780	873	960	1.048	1.075	1.125
Elementi	26	€	534,82	566,54	569,66	569,66	573,04	573,04	582,66	582,66	585,52
Lungh. (mm)	1196	Watt	549	614	715	811	907	998	1.089	1.118	1.170
Elementi	27	€	555,39	588,33	591,57	591,57	595,08	595,08	605,07	605,07	608,04
Lungh. (mm)	1242	Watt	570	637	743	842	942	1.037	1.131	1.161	1.215
Elementi	28	€	575,96	610,12	613,48	613,48	617,12	617,12	627,48	627,48	630,56
Lungh. (mm)	1288	Watt	591	661	770	874	977	1.075	1.173	1.204	1.260
Elementi	29	€	596,53	631,91	635,39	635,39	639,16	639,16	649,89	649,89	653,08
Lungh. (mm)	1334	Watt	612	684	798	905	1.012	1.114	1.215	1.247	1.305
Elementi	30	€	617,10	653,70	657,30	657,30	661,20	661,20	672,30	672,30	675,60
Lungh. (mm)	1380	Watt	633	708	825	936	1.047	1.152	1.257	1.290	1.350

Classe di sconto: F0

Zehnder Charleston

		Modello	2060	2063	2066	2068	2075	2076	2079	2086	2088	2090
2 COLONNE		Interasse (mm)	534	570	600	619	684	700	730	800	819	834
		Altezza (mm)	592	628	658	677	742	758	788	858	877	892
Elementi	3	€	67,95	69,06	69,42	70,14	74,19	75,66	76,77	78,24	81,54	83,73
Lungh. (mm)	138	Watt	136	143	149	153	165	168	173	186	189	192
Elementi	4	€	90,60	92,08	92,56	93,52	98,92	100,88	102,36	104,32	108,72	111,64
Lungh. (mm)	184	Watt	181	191	199	204	220	224	231	248	252	256
Elementi	5	€	113,25	115,10	115,70	116,90	123,65	126,10	127,95	130,40	135,90	139,55
Lungh. (mm)	230	Watt	227	239	249	255	275	280	289	310	316	320
Elementi	6	€	135,90	138,12	138,84	140,28	148,38	151,32	153,54	156,48	163,08	167,46
Lungh. (mm)	276	Watt	272	286	298	305	330	336	347	372	379	383
Elementi	7	€	158,55	161,14	161,98	163,66	173,11	176,54	179,13	182,56	190,26	195,37
Lungh. (mm)	322	Watt	317	334	348	356	385	392	405	434	442	447
Elementi	8	€	181,20	184,16	185,12	187,04	197,84	201,76	204,72	208,64	217,44	223,28
Lungh. (mm)	368	Watt	362	382	398	407	440	448	462	496	505	511
Elementi	9	€	203,85	207,18	208,26	210,42	222,57	226,98	230,31	234,72	244,62	251,19
Lungh. (mm)	414	Watt	408	429	447	458	495	504	520	558	568	575
Elementi	10	€	226,50	230,20	231,40	233,80	247,30	252,20	255,90	260,80	271,80	279,10
Lungh. (mm)	460	Watt	453	477	497	509	550	560	578	620	631	639
Elementi	11	€	249,15	253,22	254,54	257,18	272,03	277,42	281,49	286,88	298,98	307,01
Lungh. (mm)	506	Watt	498	525	547	560	605	616	636	682	694	703
Elementi	12	€	271,80	276,24	277,68	280,56	296,76	302,64	307,08	312,96	326,16	334,92
Lungh. (mm)	552	Watt	544	572	596	611	660	672	694	744	757	767
Elementi	13	€	294,45	299,26	300,82	303,94	321,49	327,86	332,67	339,04	353,34	362,83
Lungh. (mm)	598	Watt	589	620	646	662	715	728	751	806	820	831
Elementi	14	€	317,10	322,28	323,96	327,32	346,22	353,08	358,26	365,12	380,52	390,74
Lungh. (mm)	644	Watt	634	668	696	713	770	784	809	868	883	895
Elementi	15	€	339,75	345,30	347,10	350,70	370,95	378,30	383,85	391,20	407,70	418,65
Lungh. (mm)	690	Watt	680	716	746	764	825	840	867	930	947	959
Elementi	16	€	362,40	368,32	370,24	374,08	395,68	403,52	409,44	417,28	434,88	446,56
Lungh. (mm)	736	Watt	725	763	795	814	880	896	925	992	1.010	1.022
Elementi	17	€	385,05	391,34	393,38	397,46	420,41	428,74	435,03	443,36	462,06	474,47
Lungh. (mm)	782	Watt	770	811	845	865	935	952	983	1.054	1.073	1.086
Elementi	18	€	407,70	414,36	416,52	420,84	445,14	453,96	460,62	469,44	489,24	502,38
Lungh. (mm)	828	Watt	815	859	895	916	990	1.008	1.040	1.116	1.136	1.150
Elementi	19	€	430,35	437,38	439,66	444,22	469,87	479,18	486,21	495,52	516,42	530,29
Lungh. (mm)	874	Watt	861	906	944	967	1.045	1.064	1.098	1.178	1.199	1.214
Elementi	20	€	453,00	460,40	462,80	467,60	494,60	504,40	511,80	521,60	543,60	558,20
Lungh. (mm)	920	Watt	906	954	994	1.018	1.100	1.120	1.156	1.240	1.262	1.278
Elementi	21	€	475,65	483,42	485,94	490,98	519,33	529,62	537,39	547,68	570,78	586,11
Lungh. (mm)	966	Watt	951	1.002	1.044	1.069	1.155	1.176	1.214	1.302	1.325	1.342
Elementi	22	€	498,30	506,44	509,08	514,36	544,06	554,84	562,98	573,76	597,96	614,02
Lungh. (mm)	1012	Watt	997	1.049	1.093	1.120	1.210	1.232	1.272	1.364	1.388	1.406
Elementi	23	€	520,95	529,46	532,22	537,74	568,79	580,06	588,57	599,84	625,14	641,93
Lungh. (mm)	1058	Watt	1.042	1.097	1.143	1.171	1.265	1.288	1.329	1.426	1.451	1.470
Elementi	24	€	543,60	552,48	555,36	561,12	593,52	605,28	614,16	625,92	652,32	669,84
Lungh. (mm)	1104	Watt	1.087	1.145	1.193	1.222	1.320	1.344	1.387	1.488	1.514	1.534
Elementi	25	€	566,25	575,50	578,50	584,50	618,25	630,50	639,75	652,00	679,50	697,75
Lungh. (mm)	1150	Watt	1.133	1.193	1.243	1.273	1.375	1.400	1.445	1.550	1.578	1.598
Elementi	26	€	588,90	598,52	601,64	607,88	642,98	655,72	665,34	678,08	706,68	725,66
Lungh. (mm)	1196	Watt	1.178	1.240	1.292	1.323	1.430	1.456	1.503	1.612	1.641	1.661
Elementi	27	€	611,55	621,54	624,78	631,26	667,71	680,94	690,93	704,16	733,86	753,57
Lungh. (mm)	1242	Watt	1.223	1.288	1.342	1.374	1.485	1.512	1.561	1.674	1.704	1.725
Elementi	28	€	634,20	644,56	647,92	654,64	692,44	706,16	716,52	730,24	761,04	781,48
Lungh. (mm)	1288	Watt	1.268	1.336	1.392	1.425	1.540	1.568	1.618	1.736	1.767	1.789
Elementi	29	€	656,85	667,58	671,06	678,02	717,17	731,38	742,11	756,32	788,22	809,39
Lungh. (mm)	1334	Watt	1.314	1.383	1.441	1.476	1.595	1.624	1.676	1.798	1.830	1.853
Elementi	30	€	679,50	690,60	694,20	701,40	741,90	756,60	767,70	782,40	815,40	837,30
Lungh. (mm)	1380	Watt	1.359	1.431	1.491	1.527	1.650	1.680	1.734	1.860	1.893	1.917

Classe di sconto: F0

Zehnder Charleston

2093	2100	2110	2120	2150	2166	2180	2186	2200	2206	2220	2250	2280	2300
870	934	1034	1134	1434	1600	1734	1800	1934	2000	2134	2434	2734	2934
928	992	1092	1192	1492	1658	1792	1858	1992	2058	2192	2492	2792	2992
85,20	87,78	94,23	105,90	140,67	151,68	163,38	173,70	174,69	185,73	212,19	236,97	286,80	305,04
198	209	224	248	312	345	372	387	414	426	453	513	567	603
113,60	117,04	125,64	141,20	187,56	202,24	217,84	231,60	232,92	247,64	282,92	315,96	382,40	406,72
264	278	299	331	416	460	496	516	552	568	604	684	756	804
142,00	146,30	157,05	176,50	234,45	252,80	272,30	289,50	291,15	309,55	353,65	394,95	478,00	508,40
330	348	374	414	520	575	620	645	690	710	755	855	945	1.005
170,40	175,56	188,46	211,80	281,34	303,36	326,76	347,40	349,38	371,46	424,38	473,94	573,60	610,08
396	417	448	496	624	690	744	774	828	852	906	1.026	1.134	1.206
198,80	204,82	219,87	247,10	328,23	353,92	381,22	405,30	407,61	433,37	495,11	552,93	669,20	711,76
462	487	523	579	728	805	868	903	966	994	1.057	1.197	1.323	1.407
227,20	234,08	251,28	282,40	375,12	404,48	435,68	463,20	465,84	495,28	565,84	631,92	764,80	813,44
528	556	598	662	832	920	992	1.032	1.104	1.136	1.208	1.368	1.512	1.608
255,60	263,34	282,69	317,70	422,01	455,04	490,14	521,10	524,07	557,19	636,57	710,91	860,40	915,12
594	626	672	744	936	1.035	1.116	1.161	1.242	1.278	1.359	1.539	1.701	1.809
284,00	292,60	314,10	353,00	468,90	505,60	544,60	579,00	582,30	619,10	707,30	789,90	956,00	1.016,80
660	695	747	827	1.040	1.150	1.240	1.290	1.380	1.420	1.510	1.710	1.890	2.010
312,40	321,86	345,51	388,30	515,79	556,16	599,06	636,90	640,53	681,01	778,03	868,89	1.051,60	1.118,48
726	765	822	910	1.144	1.265	1.364	1.419	1.518	1.562	1.661	1.881	2.079	2.211
340,80	351,12	376,92	423,60	562,68	606,72	653,52	694,80	698,76	742,92	848,76	947,88	1.147,20	1.220,16
792	834	896	992	1.248	1.380	1.488	1.548	1.656	1.704	1.812	2.052	2.268	2.412
369,20	380,38	408,33	458,90	609,57	657,28	707,98	752,70	756,99	804,83	919,49	1.026,87	1.242,80	1.321,84
858	904	971	1.075	1.352	1.495	1.612	1.677	1.794	1.846	1.963	2.223	2.457	2.613
397,60	409,64	439,74	494,20	656,46	707,84	762,44	810,60	815,22	866,74	990,22	1.105,86	1.338,40	1.423,52
924	973	1.046	1.158	1.456	1.610	1.736	1.806	1.932	1.988	2.114	2.394	2.646	2.814
426,00	438,90	471,15	529,50	703,35	758,40	816,90	868,50	873,45	928,65	1.060,95	1.184,85	1.434,00	1.525,20
990	1.043	1.121	1.241	1.560	1.725	1.860	1.935	2.070	2.130	2.265	2.565	2.835	3.015
454,40	468,16	502,56	564,80	750,24	808,96	871,36	926,40	931,68	990,56	1.131,68	1.263,84	1.529,60	1.626,88
1.056	1.112	1.195	1.323	1.664	1.840	1.984	2.064	2.208	2.272	2.416	2.736	3.024	3.216
482,80	497,42	533,97	600,10	797,13	859,52	925,82	984,30	989,91	1.052,47	1.202,41	1.342,83	1.625,20	1.728,56
1.122	1.182	1.270	1.406	1.768	1.955	2.108	2.193	2.346	2.414	2.567	2.907	3.213	3.417
511,20	526,68	565,38	635,40	844,02	910,08	980,28	1.042,20	1.048,14	1.114,38	1.273,14	1.421,82	1.720,80	1.830,24
1.188	1.251	1.345	1.489	1.872	2.070	2.232	2.322	2.484	2.556	2.718	3.078	3.402	3.618
539,60	555,94	596,79	670,70	890,91	960,64	1.034,74	1.100,10	1.106,37	1.176,29	1.343,87	1.500,81	1.816,40	1.931,92
1.254	1.321	1.419	1.571	1.976	2.185	2.356	2.451	2.622	2.698	2.869	3.249	3.591	3.819
568,00	585,20	628,20	706,00	937,80	1.011,20	1.089,20	1.158,00	1.164,60	1.238,20	1.414,60	1.579,80	1.912,00	2.033,60
1.320	1.390	1.494	1.654	2.080	2.300	2.480	2.580	2.760	2.840	3.020	3.420	3.780	4.020
596,40	614,46	659,61	741,30	984,69	1.061,76	1.143,66	1.215,90	1.222,83	1.300,11	1.485,33	1.658,79	2.007,60	2.135,28
1.386	1.460	1.569	1.737	2.184	2.415	2.604	2.709	2.898	2.982	3.171	3.591	3.969	4.221
624,80	643,72	691,02	776,60	1.031,58	1.112,32	1.198,12	1.273,80	1.281,06	1.362,02	1.556,06	1.737,78	2.103,20	2.236,96
1.452	1.529	1.643	1.819	2.288	2.530	2.728	2.838	3.036	3.124	3.322	3.762	4.158	4.422
653,20	672,98	722,43	811,90	1.078,47	1.162,88	1.252,58	1.331,70	1.339,29	1.423,93	1.626,79	1.816,77	2.198,80	2.338,64
1.518	1.599	1.718	1.902	2.392	2.645	2.852	2.967	3.174	3.266	3.473	3.933	4.347	4.623
681,60	702,24	753,84	847,20	1.125,36	1.213,44	1.307,04	1.389,60	1.397,52	1.485,84	1.697,52	1.895,76	2.294,40	2.440,32
1.584	1.668	1.793	1.985	2.496	2.760	2.976	3.096	3.312	3.408	3.624	4.104	4.536	4.824
710,00	731,50	785,25	882,50	1.172,25	1.264,00	1.361,50	1.447,50	1.455,75	1.547,75	1.768,25	1.974,75	2.390,00	2.542,00
1.650	1.738	1.868	2.068	2.600	2.875	3.100	3.225	3.450	3.550	3.775	4.275	4.725	5.025
738,40	760,76	816,66	917,80	1.219,14	1.314,56	1.415,96	1.505,40	1.513,98	1.609,66	1.838,98	2.053,74	2.485,60	2.643,68
1.716	1.807	1.942	2.150	2.704	2.990	3.224	3.354	3.588	3.692	3.926	4.446	4.914	5.226
766,80	790,02	848,07	953,10	1.266,03	1.365,12	1.470,42	1.563,30	1.572,21	1.671,57	1.909,71	2.132,73	2.581,20	2.745,36
1.782	1.877	2.017	2.233	2.808	3.105	3.348	3.483	3.726	3.834	4.077	4.617	5.103	5.427
795,20	819,28	879,48	988,40	1.312,92	1.415,68	1.524,88	1.621,20	1.630,44	1.733,48	1.980,44	2.211,72	2.676,80	2.847,04
1.848	1.946	2.092	2.316	2.912	3.220	3.472	3.612	3.864	3.976	4.228	4.788	5.292	5.628
823,60	848,54	910,89	1.023,70	1.359,81	1.466,24	1.579,34	1.679,10	1.688,67	1.795,39	2.051,17	2.290,71	2.772,40	2.948,72
1.914	2.016	2.166	2.398	3.016	3.335	3.596	3.741	4.002	4.118	4.379	4.959	5.481	5.829
852,00	877,80	942,30	1.059,00	1.406,70	1.516,80	1.633,80	1.737,00	1.746,90	1.857,30	2.121,90	2.369,70	2.868,00	3.050,40
1.980	2.085	2.241	2.481	3.120	3.450	3.720	3.870	4.140	4.260	4.530	5.130	5.670	6.030

Classe di sconto: F0

Zehnder Charleston

MODELLO A 3 COLONNE

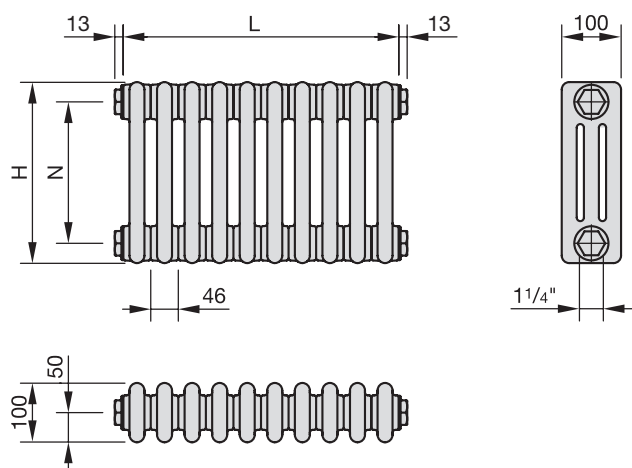

- H = altezza
 L = lunghezza = elementi x 46 mm
 N = interasse = H - 66 mm
 T = profondità
 V = contenuto d'acqua
 M = peso
 s_k = quota di irraggiamento
 q_{ms} = portata nominale
 n = esponente
 Φ_s = potenza termica nominale secondo
 EN 442 (75/65/20 °C) ΔT 50
 Φ = potenza termica con temperature del sistema ΔT 30

Quote in mm

Dati tecnici per elemento

Modello	H mm	N mm	T mm	V dm ³	M kg	s_k %	q_{ms} kg/h	Esp. n	$\Phi_s = \Delta T$ 50 EN442 Watt	$\Phi = \Delta T$ 30 55/45/20 °C Watt	Prezzo ad elemento €
3026	260	194	100	0,5	0,56	21	2,0	1,28	27,9	14,5	22,41
3030	300	234	100	0,6	0,63	20	3,0	1,28	32,0	16,6	22,41
3035	350	284	100	0,6	0,73	20	3,0	1,28	37,0	19,2	22,52
3040	400	334	100	0,7	0,83	19	4,0	1,28	41,9	21,8	22,65
3045	450	384	100	0,7	0,93	19	4,0	1,27	46,8	24,5	22,89
3050	500	434	100	0,8	1,03	18	4,0	1,27	51,6	27,0	23,14
3055	550	484	100	0,9	1,13	18	5,0	1,27	56,3	29,4	23,26
3057	566	500	100	0,9	1,16	18	4,9	1,27	57,8	30,2	23,63
3059	596	530	100	0,9	1,22	18	5,2	1,27	60,5	31,6	23,63
3060	600	534	100	0,9	1,23	18	5,0	1,27	60,9	31,8	23,63
3064	636	570	100	1,0	1,30	18	5,4	1,27	64,2	33,6	23,63
3067	666	600	100	1,0	1,36	18	5,8	1,26	66,9	35,1	23,75
3069	685	619	100	1,0	1,39	18	5,9	1,26	68,6	36,0	23,88
3075	750	684	100	1,1	1,52	18	6,0	1,26	74,3	39,0	26,08
3077	766	700	100	1,2	1,55	18	6,5	1,26	75,7	39,8	26,45
3079	796	730	100	1,2	1,61	18	6,7	1,26	77,4	40,7	27,06
3087	866	800	100	1,2	1,75	18	7,3	1,26	84,2	44,2	27,30
3089	885	819	100	1,2	1,79	18	7,5	1,26	85,8	45,1	27,67
3090	900	834	100	1,3	1,81	18	7,0	1,25	87,0	45,9	29,63
3094	936	870	100	1,3	1,88	18	7,8	1,25	90,0	47,5	34,03
3100	1000	934	100	1,4	2,01	18	8,0	1,25	95,1	50,2	34,40
3110	1100	1034	100	1,5	2,21	18	9,0	1,25	103,0	54,4	38,28
3120	1200	1134	100	1,6	2,40	18	10,0	1,31	115,0	58,9	44,14
3150	1500	1434	100	2,0	2,99	18	12,0	1,31	140,0	71,7	59,50
3167	1666	1600	100	2,0	3,32	18	13,4	1,31	154,0	78,9	66,60
3180	1800	1734	100	2,4	3,58	18	14,0	1,32	166,0	84,6	70,73
3187	1866	1800	100	2,4	3,71	18	15	1,32	171,0	87,1	75,20
3200	2000	1934	100	2,6	3,97	18	16,0	1,32	183,0	93,2	78,65
3207	2066	2000	100	2,6	4,10	18	16,3	1,32	188,0	95,8	83,45
3220	2200	2134	100	2,9	4,36	18	17,0	1,32	200,0	101,9	92,52
3250	2500	2434	100	3,2	4,95	18	19,0	1,32	225,0	114,6	100,77
3280	2800	2734	100	3,6	5,54	18	22,0	1,33	251,0	127,2	124,72
3300	3000	2934	100	3,9	5,93	18	23,0	1,33	269,0	136,4	133,90

Zehnder Charleston Retrofit: modelli con interessi adatti alle sostituzioni

Prezzo nel colore bianco RAL 9016; Supplemento per i colori della cartella colori: + 25%

Ordini possibili a partire da 2 elementi.

Classe di sconto: F0

Zehnder Charleston

3 COLONNE		Modello	3026	3030	3035	3040	3045	3050	3055	3057	3059
		Interasse (mm)	194	234	284	334	384	434	484	500	530
		Altezza (mm)	260	300	350	400	450	500	550	566	596
Elementi	3	€	67,23	67,23	67,56	67,95	68,67	69,42	69,78	70,89	70,89
Lungh. (mm)	138	Watt	84	96	111	126	140	155	169	173	182
Elementi	4	€	89,64	89,64	90,08	90,60	91,56	92,56	93,04	94,52	94,52
Lungh. (mm)	184	Watt	112	128	148	168	187	206	225	231	242
Elementi	5	€	112,05	112,05	112,60	113,25	114,45	115,70	116,30	118,15	118,15
Lungh. (mm)	230	Watt	140	160	185	210	234	258	282	289	303
Elementi	6	€	134,46	134,46	135,12	135,90	137,34	138,84	139,56	141,78	141,78
Lungh. (mm)	276	Watt	167	192	222	251	281	310	338	347	363
Elementi	7	€	156,87	156,87	157,64	158,55	160,23	161,98	162,82	165,41	165,41
Lungh. (mm)	322	Watt	195	224	259	293	328	361	394	405	424
Elementi	8	€	179,28	179,28	180,16	181,20	183,12	185,12	186,08	189,04	189,04
Lungh. (mm)	368	Watt	223	256	296	335	374	413	450	462	484
Elementi	9	€	201,69	201,69	202,68	203,85	206,01	208,26	209,34	212,67	212,67
Lungh. (mm)	414	Watt	251	288	333	377	421	464	507	520	545
Elementi	10	€	224,10	224,10	225,20	226,50	228,90	231,40	232,60	236,30	236,30
Lungh. (mm)	460	Watt	279	320	370	419	468	516	563	578	605
Elementi	11	€	246,51	246,51	247,72	249,15	251,79	254,54	255,86	259,93	259,93
Lungh. (mm)	506	Watt	307	352	407	461	515	568	619	636	666
Elementi	12	€	268,92	268,92	270,24	271,80	274,68	277,68	279,12	283,56	283,56
Lungh. (mm)	552	Watt	335	384	444	503	562	619	676	694	726
Elementi	13	€	291,33	291,33	292,76	294,45	297,57	300,82	302,38	307,19	307,19
Lungh. (mm)	598	Watt	363	416	481	545	608	671	732	751	787
Elementi	14	€	313,74	313,74	315,28	317,10	320,46	323,96	325,64	330,82	330,82
Lungh. (mm)	644	Watt	391	448	518	587	655	722	788	809	847
Elementi	15	€	336,15	336,15	337,80	339,75	343,35	347,10	348,90	354,45	354,45
Lungh. (mm)	690	Watt	419	480	555	629	702	774	845	867	908
Elementi	16	€	358,56	358,56	360,32	362,40	366,24	370,24	372,16	378,08	378,08
Lungh. (mm)	736	Watt	446	512	592	670	749	826	901	925	968
Elementi	17	€	380,97	380,97	382,84	385,05	389,13	393,38	395,42	401,71	401,71
Lungh. (mm)	782	Watt	474	544	629	712	796	877	957	983	1.029
Elementi	18	€	403,38	403,38	405,36	407,70	412,02	416,52	418,68	425,34	425,34
Lungh. (mm)	828	Watt	502	576	666	754	842	929	1.013	1.040	1.089
Elementi	19	€	425,79	425,79	427,88	430,35	434,91	439,66	441,94	448,97	448,97
Lungh. (mm)	874	Watt	530	608	703	796	889	980	1.070	1.098	1.150
Elementi	20	€	448,20	448,20	450,40	453,00	457,80	462,80	465,20	472,60	472,60
Lungh. (mm)	920	Watt	558	640	740	838	936	1.032	1.126	1.156	1.210
Elementi	21	€	470,61	470,61	472,92	475,65	480,69	485,94	488,46	496,23	496,23
Lungh. (mm)	966	Watt	586	672	777	880	983	1.084	1.182	1.214	1.271
Elementi	22	€	493,02	493,02	495,44	498,30	503,58	509,08	511,72	519,86	519,86
Lungh. (mm)	1012	Watt	614	704	814	922	1.030	1.135	1.239	1.272	1.331
Elementi	23	€	515,43	515,43	517,96	520,95	526,47	532,22	534,98	543,49	543,49
Lungh. (mm)	1058	Watt	642	736	851	964	1.076	1.187	1.295	1.329	1.392
Elementi	24	€	537,84	537,84	540,48	543,60	549,36	555,36	558,24	567,12	567,12
Lungh. (mm)	1104	Watt	670	768	888	1.006	1.123	1.238	1.351	1.387	1.452
Elementi	25	€	560,25	560,25	563,00	566,25	572,25	578,50	581,50	590,75	590,75
Lungh. (mm)	1150	Watt	698	800	925	1.048	1.170	1.290	1.408	1.445	1.513
Elementi	26	€	582,66	582,66	585,52	588,90	595,14	601,64	604,76	614,38	614,38
Lungh. (mm)	1196	Watt	725	832	962	1.089	1.217	1.342	1.464	1.503	1.573
Elementi	27	€	605,07	605,07	608,04	611,55	618,03	624,78	628,02	638,01	638,01
Lungh. (mm)	1242	Watt	753	864	999	1.131	1.264	1.393	1.520	1.561	1.634
Elementi	28	€	627,48	627,48	630,56	634,20	640,92	647,92	651,28	661,64	661,64
Lungh. (mm)	1288	Watt	781	896	1.036	1.173	1.310	1.445	1.576	1.618	1.694
Elementi	29	€	649,89	649,89	653,08	656,85	663,81	671,06	674,54	685,27	685,27
Lungh. (mm)	1334	Watt	809	928	1.073	1.215	1.357	1.496	1.633	1.676	1.755
Elementi	30	€	672,30	672,30	675,60	679,50	686,70	694,20	697,80	708,90	708,90
Lungh. (mm)	1380	Watt	837	960	1.110	1.257	1.404	1.548	1.689	1.734	1.815

Classe di sconto: F0

Zehnder Charleston

		Modello	3060	3064	3067	3069	3075	3077	3079	3087	3089	3090
3 COLONNE		Interasse (mm)	534	570	600	619	684	700	730	800	819	834
		Altezza (mm)	600	636	666	685	750	766	796	866	885	900
Elementi	3	€	70,89	70,89	71,25	71,64	78,24	79,35	81,18	81,90	83,01	88,89
Lungh. (mm)	138	Watt	183	193	201	206	223	227	232	253	257	261
Elementi	4	€	94,52	94,52	95,00	95,52	104,32	105,80	108,24	109,20	110,68	118,52
Lungh. (mm)	184	Watt	244	257	268	274	297	303	310	337	343	348
Elementi	5	€	118,15	118,15	118,75	119,40	130,40	132,25	135,30	136,50	138,35	148,15
Lungh. (mm)	230	Watt	305	321	335	343	372	379	387	421	429	435
Elementi	6	€	141,78	141,78	142,50	143,28	156,48	158,70	162,36	163,80	166,02	177,78
Lungh. (mm)	276	Watt	365	385	401	412	446	454	464	505	515	522
Elementi	7	€	165,41	165,41	166,25	167,16	182,56	185,15	189,42	191,10	193,69	207,41
Lungh. (mm)	322	Watt	426	449	468	480	520	530	542	589	601	609
Elementi	8	€	189,04	189,04	190,00	191,04	208,64	211,60	216,48	218,40	221,36	237,04
Lungh. (mm)	368	Watt	487	514	535	549	594	606	619	674	686	696
Elementi	9	€	212,67	212,67	213,75	214,92	234,72	238,05	243,54	245,70	249,03	266,67
Lungh. (mm)	414	Watt	548	578	602	617	669	681	697	758	772	783
Elementi	10	€	236,30	236,30	237,50	238,80	260,80	264,50	270,60	273,00	276,70	296,30
Lungh. (mm)	460	Watt	609	642	669	686	743	757	774	842	858	870
Elementi	11	€	259,93	259,93	261,25	262,68	286,88	290,95	297,66	300,30	304,37	325,93
Lungh. (mm)	506	Watt	670	706	736	755	817	833	851	926	944	957
Elementi	12	€	283,56	283,56	285,00	286,56	312,96	317,40	324,72	327,60	332,04	355,56
Lungh. (mm)	552	Watt	731	770	803	823	892	908	929	1.010	1.030	1.044
Elementi	13	€	307,19	307,19	308,75	310,44	339,04	343,85	351,78	354,90	359,71	385,19
Lungh. (mm)	598	Watt	792	835	870	892	966	984	1.006	1.095	1.115	1.131
Elementi	14	€	330,82	330,82	332,50	334,32	365,12	370,30	378,84	382,20	387,38	414,82
Lungh. (mm)	644	Watt	853	899	937	960	1.040	1.060	1.084	1.179	1.201	1.218
Elementi	15	€	354,45	354,45	356,25	358,20	391,20	396,75	405,90	409,50	415,05	444,45
Lungh. (mm)	690	Watt	914	963	1.004	1.029	1.115	1.136	1.161	1.263	1.287	1.305
Elementi	16	€	378,08	378,08	380,00	382,08	417,28	423,20	432,96	436,80	442,72	474,08
Lungh. (mm)	736	Watt	974	1.027	1.070	1.098	1.189	1.211	1.238	1.347	1.373	1.392
Elementi	17	€	401,71	401,71	403,75	405,96	443,36	449,65	460,02	464,10	470,39	503,71
Lungh. (mm)	782	Watt	1.035	1.091	1.137	1.166	1.263	1.287	1.316	1.431	1.459	1.479
Elementi	18	€	425,34	425,34	427,50	429,84	469,44	476,10	487,08	491,40	498,06	533,34
Lungh. (mm)	828	Watt	1.096	1.156	1.204	1.235	1.337	1.363	1.393	1.516	1.544	1.566
Elementi	19	€	448,97	448,97	451,25	453,72	495,52	502,55	514,14	518,70	525,73	562,97
Lungh. (mm)	874	Watt	1.157	1.220	1.271	1.303	1.412	1.438	1.471	1.600	1.630	1.653
Elementi	20	€	472,60	472,60	475,00	477,60	521,60	529,00	541,20	546,00	553,40	592,60
Lungh. (mm)	920	Watt	1.218	1.284	1.338	1.372	1.486	1.514	1.548	1.684	1.716	1.740
Elementi	21	€	496,23	496,23	498,75	501,48	547,68	555,45	568,26	573,30	581,07	622,23
Lungh. (mm)	966	Watt	1.279	1.348	1.405	1.441	1.560	1.590	1.625	1.768	1.802	1.827
Elementi	22	€	519,86	519,86	522,50	525,36	573,76	581,90	595,32	600,60	608,74	651,86
Lungh. (mm)	1012	Watt	1.340	1.412	1.472	1.509	1.635	1.665	1.703	1.852	1.888	1.914
Elementi	23	€	543,49	543,49	546,25	549,24	599,84	608,35	622,38	627,90	636,41	681,49
Lungh. (mm)	1058	Watt	1.401	1.477	1.539	1.578	1.709	1.741	1.780	1.937	1.973	2.001
Elementi	24	€	567,12	567,12	570,00	573,12	625,92	634,80	649,44	655,20	664,08	711,12
Lungh. (mm)	1104	Watt	1.462	1.541	1.606	1.646	1.783	1.817	1.858	2.021	2.059	2.088
Elementi	25	€	590,75	590,75	593,75	597,00	652,00	661,25	676,50	682,50	691,75	740,75
Lungh. (mm)	1150	Watt	1.523	1.605	1.673	1.715	1.858	1.893	1.935	2.105	2.145	2.175
Elementi	26	€	614,38	614,38	617,50	620,88	678,08	687,70	703,56	709,80	719,42	770,38
Lungh. (mm)	1196	Watt	1.583	1.669	1.739	1.784	1.932	1.968	2.012	2.189	2.231	2.262
Elementi	27	€	638,01	638,01	641,25	644,76	704,16	714,15	730,62	737,10	747,09	800,01
Lungh. (mm)	1242	Watt	1.644	1.733	1.806	1.852	2.006	2.044	2.090	2.273	2.317	2.349
Elementi	28	€	661,64	661,64	665,00	668,64	730,24	740,60	757,68	764,40	774,76	829,64
Lungh. (mm)	1288	Watt	1.705	1.798	1.873	1.921	2.080	2.120	2.167	2.358	2.402	2.436
Elementi	29	€	685,27	685,27	688,75	692,52	756,32	767,05	784,74	791,70	802,43	859,27
Lungh. (mm)	1334	Watt	1.766	1.862	1.940	1.989	2.155	2.195	2.245	2.442	2.488	2.523
Elementi	30	€	708,90	708,90	712,50	716,40	782,40	793,50	811,80	819,00	830,10	888,90
Lungh. (mm)	1380	Watt	1.827	1.926	2.007	2.058	2.229	2.271	2.322	2.526	2.574	2.610

Classe di sconto: F0

Zehnder Charleston

3094	3100	3110	3120	3150	3167	3180	3187	3200	3207	3220	3250	3280	3300
870	934	1034	1134	1434	1600	1734	1800	1934	2000	2134	2434	2734	2934
936	1000	1100	1200	1500	1666	1800	1866	2000	2066	2200	2500	2800	3000
102,09	103,20	114,84	132,42	178,50	199,80	212,19	225,60	235,95	250,35	277,56	302,31	374,16	401,70
270	285	309	345	420	462	498	513	549	564	600	675	753	807
136,12	137,60	153,12	176,56	238,00	266,40	282,92	300,80	314,60	333,80	370,08	403,08	498,88	535,60
360	380	412	460	560	616	664	684	732	752	800	900	1.004	1.076
170,15	172,00	191,40	220,70	297,50	333,00	353,65	376,00	393,25	417,25	462,60	503,85	623,60	669,50
450	476	515	575	700	770	830	855	915	940	1.000	1.125	1.255	1.345
204,18	206,40	229,68	264,84	357,00	399,60	424,38	451,20	471,90	500,70	555,12	604,62	748,32	803,40
540	571	618	690	840	924	996	1.026	1.098	1.128	1.200	1.350	1.506	1.614
238,21	240,80	267,96	308,98	416,50	466,20	495,11	526,40	550,55	584,15	647,64	705,39	873,04	937,30
630	666	721	805	980	1.078	1.162	1.197	1.281	1.316	1.400	1.575	1.757	1.883
272,24	275,20	306,24	353,12	476,00	532,80	565,84	601,60	629,20	667,60	740,16	806,16	997,76	1.071,20
720	761	824	920	1.120	1.232	1.328	1.368	1.464	1.504	1.600	1.800	2.008	2.152
306,27	309,60	344,52	397,26	535,50	599,40	636,57	676,80	707,85	751,05	832,68	906,93	1.122,48	1.205,10
810	856	927	1.035	1.260	1.386	1.494	1.539	1.647	1.692	1.800	2.025	2.259	2.421
340,30	344,00	382,80	441,40	595,00	666,00	707,30	752,00	786,50	834,50	925,20	1.007,70	1.247,20	1.339,00
900	951	1.030	1.150	1.400	1.540	1.660	1.710	1.830	1.880	2.000	2.250	2.510	2.690
374,33	378,40	421,08	485,54	654,50	732,60	778,03	827,20	865,15	917,95	1.017,72	1.108,47	1.371,92	1.472,90
990	1.046	1.133	1.265	1.540	1.694	1.826	1.881	2.013	2.068	2.200	2.475	2.761	2.959
408,36	412,80	459,36	529,68	714,00	799,20	848,76	902,40	943,80	1.001,40	1.110,24	1.209,24	1.496,64	1.606,80
1.080	1.141	1.236	1.380	1.680	1.848	1.992	2.052	2.196	2.256	2.400	2.700	3.012	3.228
442,39	447,20	497,64	573,82	773,50	865,80	919,49	977,60	1.022,45	1.084,85	1.202,76	1.310,01	1.621,36	1.740,70
1.170	1.236	1.339	1.495	1.820	2.002	2.158	2.223	2.379	2.444	2.600	2.925	3.263	3.497
476,42	481,60	535,92	617,96	833,00	932,40	990,22	1.052,80	1.101,10	1.168,30	1.295,28	1.410,78	1.746,08	1.874,60
1.260	1.331	1.442	1.610	1.960	2.156	2.324	2.394	2.562	2.632	2.800	3.150	3.514	3.766
510,45	516,00	574,20	662,10	892,50	999,00	1.060,95	1.128,00	1.179,75	1.251,75	1.387,80	1.511,55	1.870,80	2.008,50
1.350	1.427	1.545	1.725	2.100	2.310	2.490	2.565	2.745	2.820	3.000	3.375	3.765	4.035
544,48	550,40	612,48	706,24	952,00	1.065,60	1.131,68	1.203,20	1.258,40	1.335,20	1.480,32	1.612,32	1.995,52	2.142,40
1.440	1.522	1.648	1.840	2.240	2.464	2.656	2.736	2.928	3.008	3.200	3.600	4.016	4.304
578,51	584,80	650,76	750,38	1.011,50	1.132,20	1.202,41	1.278,40	1.337,05	1.418,65	1.572,84	1.713,09	2.120,24	2.276,30
1.530	1.617	1.751	1.955	2.380	2.618	2.822	2.907	3.111	3.196	3.400	3.825	4.267	4.573
612,54	619,20	689,04	794,52	1.071,00	1.198,80	1.273,14	1.353,60	1.415,70	1.502,10	1.665,36	1.813,86	2.244,96	2.410,20
1.620	1.712	1.854	2.070	2.520	2.772	2.988	3.078	3.294	3.384	3.600	4.050	4.518	4.842
646,57	653,60	727,32	838,66	1.130,50	1.265,40	1.343,87	1.428,80	1.494,35	1.585,55	1.757,88	1.914,63	2.369,68	2.544,10
1.710	1.807	1.957	2.185	2.660	2.926	3.154	3.249	3.477	3.572	3.800	4.275	4.769	5.111
680,60	688,00	765,60	882,80	1.190,00	1.332,00	1.414,60	1.504,00	1.573,00	1.669,00	1.850,40	2.015,40	2.494,40	2.678,00
1.800	1.902	2.060	2.300	2.800	3.080	3.320	3.420	3.660	3.760	4.000	4.500	5.020	5.380
714,63	722,40	803,88	926,94	1.249,50	1.398,60	1.485,33	1.579,20	1.651,65	1.752,45	1.942,92	2.116,17	2.619,12	2.811,90
1.890	1.997	2.163	2.415	2.940	3.234	3.486	3.591	3.843	3.948	4.200	4.725	5.271	5.649
748,66	756,80	842,16	971,08	1.309,00	1.465,20	1.556,06	1.654,40	1.730,30	1.835,90	2.035,44	2.216,94	2.743,84	2.945,80
1.980	2.092	2.266	2.530	3.080	3.388	3.652	3.762	4.026	4.136	4.400	4.950	5.522	5.918
782,69	791,20	880,44	1.015,22	1.368,50	1.531,80	1.626,79	1.729,60	1.808,95	1.919,35	2.127,96	2.317,71	2.868,56	3.079,70
2.070	2.187	2.369	2.645	3.220	3.542	3.818	3.933	4.209	4.324	4.600	5.175	5.773	6.187
816,72	825,60	918,72	1.059,36	1.428,00	1.598,40	1.697,52	1.804,80	1.887,60	2.002,80	2.220,48	2.418,48	2.993,28	3.213,60
2.160	2.282	2.472	2.760	3.360	3.696	3.984	4.104	4.392	4.512	4.800	5.400	6.024	6.456
850,75	860,00	957,00	1.103,50	1.487,50	1.665,00	1.768,25	1.880,00	1.966,25	2.086,25	2.313,00	2.519,25	3.118,00	3.347,50
2.250	2.378	2.575	2.875	3.500	3.850	4.150	4.275	4.575	4.700	5.000	5.625	6.275	6.725
884,78	894,40	995,28	1.147,64	1.547,00	1.731,60	1.838,98	1.955,20	2.044,90	2.169,70	2.405,52	2.620,02	3.242,72	3.481,40
2.340	2.473	2.678	2.990	3.640	4.004	4.316	4.446	4.758	4.888	5.200	5.850	6.526	6.994
918,81	928,80	1.033,56	1.191,78	1.606,50	1.798,20	1.909,71	2.030,40	2.123,55	2.253,15	2.498,04	2.720,79	3.367,44	3.615,30
2.430	2.568	2.781	3.105	3.780	4.158	4.482	4.617	4.941	5.076	5.400	6.075	6.777	7.263
952,84	963,20	1.071,84	1.235,92	1.666,00	1.864,80	1.980,44	2.105,60	2.202,20	2.336,60	2.590,56	2.821,56	3.492,16	3.749,20
2.520	2.663	2.884	3.220	3.920	4.312	4.648	4.788	5.124	5.264	5.600	6.300	7.028	7.532
986,87	997,60	1.110,12	1.280,06	1.725,50	1.931,40	2.051,17	2.180,80	2.280,85	2.420,05	2.683,08	2.922,33	3.616,88	3.883,10
2.610	2.758	2.987	3.335	4.060	4.466	4.814	4.959	5.307	5.452	5.800	6.525	7.279	7.801
1.020,90	1.032,00	1.148,40	1.324,20	1.785,00	1.998,00	2.121,90	2.256,00	2.359,50	2.503,50	2.775,60	3.023,10	3.741,60	4.017,00
2.700	2.853	3.090	3.450	4.200	4.620	4.980	5.130	5.490	5.640	6.000	6.750	7.530	8.070

Classe di sconto: F0

Zehnder Charleston

MODELLO A 4 COLONNE

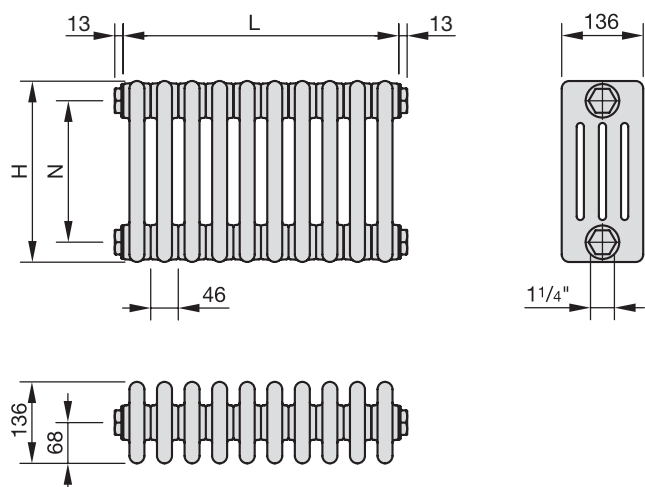

- H = altezza
 L = lunghezza = elementi x 46 mm
 N = interasse = H - 66 mm
 T = profondità
 V = contenuto d'acqua
 M = peso
 S_k = quota di irraggiamento
 q_{ms} = portata nominale
 n = esponente
 Φ_s = potenza termica nominale secondo
 EN 442 (75/65/20 °C) ΔT 50
 Φ = potenza termica con temperature del sistema ΔT 30

Quote in mm

Dati tecnici per elemento

Modello	H	N	T	V	M	S_k	q_{ms}	Esp.	$\Phi_s = \Delta T$ 50	$\Phi = \Delta T$ 30	Prezzo ad
	mm	mm	mm	dm ³	kg	%	kg/h	n	EN442 Watt	55/45/20 °C Watt	elemento €
4026	260	194	136	0,7	0,77	18	3,0	1,28	36,5	19,0	25,71
4030	300	234	136	0,7	0,88	18	4,0	1,28	41,9	21,8	26,45
4035	350	284	136	0,8	1,01	17	4,0	1,28	48,5	25,2	26,45
4040	400	334	136	0,9	1,16	16	5,0	1,28	54,9	28,5	26,82
4045	450	384	136	1,0	1,29	16	5,0	1,27	61,3	32,0	26,82
4050	500	434	136	1,0	1,42	16	6,0	1,27	67,6	35,3	26,93
4055	550	484	136	1,1	1,55	16	6,0	1,27	73,7	38,5	26,93
4057	566	500	136	1,1	1,59	15	6,4	1,27	75,7	39,6	26,93
4059	596	530	136	1,2	1,66	15	6,8	1,27	79,3	41,5	27,18
4060	600	534	136	1,2	1,67	15	7,0	1,27	79,8	41,7	28,16
4064	636	570	136	1,2	1,77	15	7,2	1,27	84,1	44,0	28,28
4067	666	600	136	1,3	1,84	15	7,4	1,26	87,6	46,0	28,40
4069	685	619	136	1,3	1,89	15	7,7	1,26	89,9	47,2	28,53
4075	750	684	136	1,4	2,06	15	8,0	1,26	97,4	51,2	31,95
4077	766	700	136	1,5	2,10	15	8,6	1,26	99,2	52,1	32,08
4079	796	730	136	1,5	2,18	15	8,8	1,26	103,0	54,1	32,20
4087	866	800	136	1,6	2,36	15	9,3	1,26	111,0	58,3	33,05
4089	885	819	136	1,6	2,41	15	9,5	1,26	112,0	58,8	34,16
4090	900	834	136	1,7	2,45	15	10,0	1,25	114,0	60,2	34,16
4094	936	870	136	1,7	2,54	15	10,1	1,25	118,0	62,3	40,65
4100	1000	934	136	1,8	2,70	15	11,0	1,25	125,0	66,0	41,51
4110	1100	1034	136	2,0	2,96	15	12,0	1,25	135,0	71,3	46,43
4120	1200	1134	136	2,1	3,22	15	13,0	1,31	147,0	75,3	54,34
4150	1500	1434	136	2,6	3,99	15	15,0	1,31	180,0	92,2	73,26
4167	1666	1600	136	2,1	4,42	15	17,1	1,31	198,0	101,4	82,66
4180	1800	1734	136	3,1	4,76	15	18,0	1,32	213,0	108,5	87,93
4187	1866	1800	136	3,1	4,93	15	18,8	1,32	220,0	112,1	92,40
4200	2000	1934	136	3,4	5,28	15	20,0	1,32	234,0	119,2	96,06
4207	2066	2000	136	3,4	5,44	15	20,8	1,32	242,0	123,3	100,88
4220	2200	2134	136	3,8	5,79	15	22,0	1,32	256,0	130,4	112,35
4250	2500	2434	136	4,3	6,56	15	25,0	1,32	289,0	147,3	122,31
4280	2800	2734	136	4,8	7,33	15	28,0	1,33	323,0	163,7	152,59
4300	3000	2934	136	5,1	7,85	15	30,0	1,33	345,0	174,9	159,23

Zehnder Charleston Retrofit: modelli con interassi adatti alle sostituzioni

Prezzo nel colore bianco RAL 9016; Supplemento per i colori della cartella colori: + 25%

Ordini possibili a partire da 2 elementi.

Classe di sconto: F0

Zehnder Charleston

4 COLONNE		Modello	4026	4030	4035	4040	4045	4050	4055	4057	4059
		Interasse (mm)	194	234	284	334	384	434	484	500	530
		Altezza (mm)	260	300	350	400	450	500	550	566	596
Elementi	3	€	77,13	79,35	79,35	80,46	80,46	80,79	80,79	80,79	81,54
Lungh. (mm)	138	Watt	110	126	146	165	184	203	221	227	238
Elementi	4	€	102,84	105,80	105,80	107,28	107,28	107,72	107,72	107,72	108,72
Lungh. (mm)	184	Watt	146	168	194	220	245	270	295	303	317
Elementi	5	€	128,55	132,25	132,25	134,10	134,10	134,65	134,65	134,65	135,90
Lungh. (mm)	230	Watt	183	210	243	275	307	338	369	379	397
Elementi	6	€	154,26	158,70	158,70	160,92	160,92	161,58	161,58	161,58	163,08
Lungh. (mm)	276	Watt	219	251	291	329	368	406	442	454	476
Elementi	7	€	179,97	185,15	185,15	187,74	187,74	188,51	188,51	188,51	190,26
Lungh. (mm)	322	Watt	256	293	340	384	429	473	516	530	555
Elementi	8	€	205,68	211,60	211,60	214,56	214,56	215,44	215,44	215,44	217,44
Lungh. (mm)	368	Watt	292	335	388	439	490	541	590	606	634
Elementi	9	€	231,39	238,05	238,05	241,38	241,38	242,37	242,37	242,37	244,62
Lungh. (mm)	414	Watt	329	377	437	494	552	608	663	681	714
Elementi	10	€	257,10	264,50	264,50	268,20	268,20	269,30	269,30	269,30	271,80
Lungh. (mm)	460	Watt	365	419	485	549	613	676	737	757	793
Elementi	11	€	282,81	290,95	290,95	295,02	295,02	296,23	296,23	296,23	298,98
Lungh. (mm)	506	Watt	402	461	534	604	674	744	811	833	872
Elementi	12	€	308,52	317,40	317,40	321,84	321,84	323,16	323,16	323,16	326,16
Lungh. (mm)	552	Watt	438	503	582	659	736	811	884	908	952
Elementi	13	€	334,23	343,85	343,85	348,66	348,66	350,09	350,09	350,09	353,34
Lungh. (mm)	598	Watt	475	545	631	714	797	879	958	984	1.031
Elementi	14	€	359,94	370,30	370,30	375,48	375,48	377,02	377,02	377,02	380,52
Lungh. (mm)	644	Watt	511	587	679	769	858	946	1.032	1.060	1.110
Elementi	15	€	385,65	396,75	396,75	402,30	402,30	403,95	403,95	403,95	407,70
Lungh. (mm)	690	Watt	548	629	728	824	920	1.014	1.106	1.136	1.190
Elementi	16	€	411,36	423,20	423,20	429,12	429,12	430,88	430,88	430,88	434,88
Lungh. (mm)	736	Watt	584	670	776	878	981	1.082	1.179	1.211	1.269
Elementi	17	€	437,07	449,65	449,65	455,94	455,94	457,81	457,81	457,81	462,06
Lungh. (mm)	782	Watt	621	712	825	933	1.042	1.149	1.253	1.287	1.348
Elementi	18	€	462,78	476,10	476,10	482,76	482,76	484,74	484,74	484,74	489,24
Lungh. (mm)	828	Watt	657	754	873	988	1.103	1.217	1.327	1.363	1.427
Elementi	19	€	488,49	502,55	502,55	509,58	509,58	511,67	511,67	511,67	516,42
Lungh. (mm)	874	Watt	694	796	922	1.043	1.165	1.284	1.400	1.438	1.507
Elementi	20	€	514,20	529,00	529,00	536,40	536,40	538,60	538,60	538,60	543,60
Lungh. (mm)	920	Watt	730	838	970	1.098	1.226	1.352	1.474	1.514	1.586
Elementi	21	€	539,91	555,45	555,45	563,22	563,22	565,53	565,53	565,53	570,78
Lungh. (mm)	966	Watt	767	880	1.019	1.153	1.287	1.420	1.548	1.590	1.665
Elementi	22	€	565,62	581,90	581,90	590,04	590,04	592,46	592,46	592,46	597,96
Lungh. (mm)	1012	Watt	803	922	1.067	1.208	1.349	1.487	1.621	1.665	1.745
Elementi	23	€	591,33	608,35	608,35	616,86	616,86	619,39	619,39	619,39	625,14
Lungh. (mm)	1058	Watt	840	964	1.116	1.263	1.410	1.555	1.695	1.741	1.824
Elementi	24	€	617,04	634,80	634,80	643,68	643,68	646,32	646,32	646,32	652,32
Lungh. (mm)	1104	Watt	876	1.006	1.164	1.318	1.471	1.622	1.769	1.817	1.903
Elementi	25	€	642,75	661,25	661,25	670,50	670,50	673,25	673,25	673,25	679,50
Lungh. (mm)	1150	Watt	913	1.048	1.213	1.373	1.533	1.690	1.843	1.893	1.983
Elementi	26	€	668,46	687,70	687,70	697,32	697,32	700,18	700,18	700,18	706,68
Lungh. (mm)	1196	Watt	949	1.089	1.261	1.427	1.594	1.758	1.916	1.968	2.062
Elementi	27	€	694,17	714,15	714,15	724,14	724,14	727,11	727,11	727,11	733,86
Lungh. (mm)	1242	Watt	986	1.131	1.310	1.482	1.655	1.825	1.990	2.044	2.141
Elementi	28	€	719,88	740,60	740,60	750,96	750,96	754,04	754,04	754,04	761,04
Lungh. (mm)	1288	Watt	1.022	1.173	1.358	1.537	1.716	1.893	2.064	2.120	2.220
Elementi	29	€	745,59	767,05	767,05	777,78	777,78	780,97	780,97	780,97	788,22
Lungh. (mm)	1334	Watt	1.059	1.215	1.407	1.592	1.778	1.960	2.137	2.195	2.300
Elementi	30	€	771,30	793,50	793,50	804,60	804,60	807,90	807,90	807,90	815,40
Lungh. (mm)	1380	Watt	1.095	1.257	1.455	1.647	1.839	2.028	2.211	2.271	2.379

Classe di sconto: F0

Zehnder Charleston

		Modello	4060	4064	4067	4069	4075	4077	4079	4087	4089	4090
4 COLONNE		Interasse (mm)	534	570	600	619	684	700	730	800	819	834
		Altezza (mm)	600	636	666	685	750	766	796	866	885	900
Elementi	3	€	84,48	84,84	85,20	85,59	95,85	96,24	96,60	99,15	102,48	102,48
Lungh. (mm)	138	Watt	239	252	263	270	292	298	309	333	336	342
Elementi	4	€	112,64	113,12	113,60	114,12	127,80	128,32	128,80	132,20	136,64	136,64
Lungh. (mm)	184	Watt	319	336	350	360	390	397	412	444	448	456
Elementi	5	€	140,80	141,40	142,00	142,65	159,75	160,40	161,00	165,25	170,80	170,80
Lungh. (mm)	230	Watt	399	421	438	450	487	496	515	555	560	570
Elementi	6	€	168,96	169,68	170,40	171,18	191,70	192,48	193,20	198,30	204,96	204,96
Lungh. (mm)	276	Watt	479	505	526	539	584	595	618	666	672	684
Elementi	7	€	197,12	197,96	198,80	199,71	223,65	224,56	225,40	231,35	239,12	239,12
Lungh. (mm)	322	Watt	559	589	613	629	682	694	721	777	784	798
Elementi	8	€	225,28	226,24	227,20	228,24	255,60	256,64	257,60	264,40	273,28	273,28
Lungh. (mm)	368	Watt	638	673	701	719	779	794	824	888	896	912
Elementi	9	€	253,44	254,52	255,60	256,77	287,55	288,72	289,80	297,45	307,44	307,44
Lungh. (mm)	414	Watt	718	757	788	809	877	893	927	999	1.008	1.026
Elementi	10	€	281,60	282,80	284,00	285,30	319,50	320,80	322,00	330,50	341,60	341,60
Lungh. (mm)	460	Watt	798	841	876	899	974	992	1.030	1.110	1.120	1.140
Elementi	11	€	309,76	311,08	312,40	313,83	351,45	352,88	354,20	363,55	375,76	375,76
Lungh. (mm)	506	Watt	878	925	964	989	1.071	1.091	1.133	1.221	1.232	1.254
Elementi	12	€	337,92	339,36	340,80	342,36	383,40	384,96	386,40	396,60	409,92	409,92
Lungh. (mm)	552	Watt	958	1.009	1.051	1.079	1.169	1.190	1.236	1.332	1.344	1.368
Elementi	13	€	366,08	367,64	369,20	370,89	415,35	417,04	418,60	429,65	444,08	444,08
Lungh. (mm)	598	Watt	1.037	1.093	1.139	1.169	1.266	1.290	1.339	1.443	1.456	1.482
Elementi	14	€	394,24	395,92	397,60	399,42	447,30	449,12	450,80	462,70	478,24	478,24
Lungh. (mm)	644	Watt	1.117	1.177	1.226	1.259	1.364	1.389	1.442	1.554	1.568	1.596
Elementi	15	€	422,40	424,20	426,00	427,95	479,25	481,20	483,00	495,75	512,40	512,40
Lungh. (mm)	690	Watt	1.197	1.262	1.314	1.349	1.461	1.488	1.545	1.665	1.680	1.710
Elementi	16	€	450,56	452,48	454,40	456,48	511,20	513,28	515,20	528,80	546,56	546,56
Lungh. (mm)	736	Watt	1.277	1.346	1.402	1.438	1.558	1.587	1.648	1.776	1.792	1.824
Elementi	17	€	478,72	480,76	482,80	485,01	543,15	545,36	547,40	561,85	580,72	580,72
Lungh. (mm)	782	Watt	1.357	1.430	1.489	1.528	1.656	1.686	1.751	1.887	1.904	1.938
Elementi	18	€	506,88	509,04	511,20	513,54	575,10	577,44	579,60	594,90	614,88	614,88
Lungh. (mm)	828	Watt	1.436	1.514	1.577	1.618	1.753	1.786	1.854	1.998	2.016	2.052
Elementi	19	€	535,04	537,32	539,60	542,07	607,05	609,52	611,80	627,95	649,04	649,04
Lungh. (mm)	874	Watt	1.516	1.598	1.664	1.708	1.851	1.885	1.957	2.109	2.128	2.166
Elementi	20	€	563,20	565,60	568,00	570,60	639,00	641,60	644,00	661,00	683,20	683,20
Lungh. (mm)	920	Watt	1.596	1.682	1.752	1.798	1.948	1.984	2.060	2.220	2.240	2.280
Elementi	21	€	591,36	593,88	596,40	599,13	670,95	673,68	676,20	694,05	717,36	717,36
Lungh. (mm)	966	Watt	1.676	1.766	1.840	1.888	2.045	2.083	2.163	2.331	2.352	2.394
Elementi	22	€	619,52	622,16	624,80	627,66	702,90	705,76	708,40	727,10	751,52	751,52
Lungh. (mm)	1012	Watt	1.756	1.850	1.927	1.978	2.143	2.182	2.266	2.442	2.464	2.508
Elementi	23	€	647,68	650,44	653,20	656,19	734,85	737,84	740,60	760,15	785,68	785,68
Lungh. (mm)	1058	Watt	1.835	1.934	2.015	2.068	2.240	2.282	2.369	2.553	2.576	2.622
Elementi	24	€	675,84	678,72	681,60	684,72	766,80	769,92	772,80	793,20	819,84	819,84
Lungh. (mm)	1104	Watt	1.915	2.018	2.102	2.158	2.338	2.381	2.472	2.664	2.688	2.736
Elementi	25	€	704,00	707,00	710,00	713,25	798,75	802,00	805,00	826,25	854,00	854,00
Lungh. (mm)	1150	Watt	1.995	2.103	2.190	2.248	2.435	2.480	2.575	2.775	2.800	2.850
Elementi	26	€	732,16	735,28	738,40	741,78	830,70	834,08	837,20	859,30	888,16	888,16
Lungh. (mm)	1196	Watt	2.075	2.187	2.278	2.337	2.532	2.579	2.678	2.886	2.912	2.964
Elementi	27	€	760,32	763,56	766,80	770,31	862,65	866,16	869,40	892,35	922,32	922,32
Lungh. (mm)	1242	Watt	2.155	2.271	2.365	2.427	2.630	2.678	2.781	2.997	3.024	3.078
Elementi	28	€	788,48	791,84	795,20	798,84	894,60	898,24	901,60	925,40	956,48	956,48
Lungh. (mm)	1288	Watt	2.234	2.355	2.453	2.517	2.727	2.778	2.884	3.108	3.136	3.192
Elementi	29	€	816,64	820,12	823,60	827,37	926,55	930,32	933,80	958,45	990,64	990,64
Lungh. (mm)	1334	Watt	2.314	2.439	2.540	2.607	2.825	2.877	2.987	3.219	3.248	3.306
Elementi	30	€	844,80	848,40	852,00	855,90	958,50	962,40	966,00	991,50	1.024,80	1.024,80
Lungh. (mm)	1380	Watt	2.394	2.523	2.628	2.697	2.922	2.976	3.090	3.330	3.360	3.420

Classe di sconto: F0

Zehnder Charleston

4094	4100	4110	4120	4150	4167	4180	4187	4200	4207	4220	4250	4280	4300
870	934	1034	1134	1434	1600	1734	1800	1934	2000	2134	2434	2734	2934
936	1000	1100	1200	1500	1666	1800	1866	2000	2066	2200	2500	2800	3000
121,95	124,53	139,29	163,02	219,78	247,98	263,79	277,20	288,18	302,64	337,05	366,93	457,77	477,69
354	375	405	441	540	594	639	660	702	726	768	867	969	1.035
162,60	166,04	185,72	217,36	293,04	330,64	351,72	369,60	384,24	403,52	449,40	489,24	610,36	636,92
472	500	540	588	720	792	852	880	936	968	1.024	1.156	1.292	1.380
203,25	207,55	232,15	271,70	366,30	413,30	439,65	462,00	480,30	504,40	561,75	611,55	762,95	796,15
590	625	675	735	900	990	1.065	1.100	1.170	1.210	1.280	1.445	1.615	1.725
243,90	249,06	278,58	326,04	439,56	495,96	527,58	554,40	576,36	605,28	674,10	733,86	915,54	955,38
708	750	810	882	1.080	1.188	1.278	1.320	1.404	1.452	1.536	1.734	1.938	2.070
284,55	290,57	325,01	380,38	512,82	578,62	615,51	646,80	672,42	706,16	786,45	856,17	1.068,13	1.114,61
826	875	945	1.029	1.260	1.386	1.491	1.540	1.638	1.694	1.792	2.023	2.261	2.415
325,20	332,08	371,44	434,72	586,08	661,28	703,44	739,20	768,48	807,04	898,80	978,48	1.220,72	1.273,84
944	1.000	1.080	1.176	1.440	1.584	1.704	1.760	1.872	1.936	2.048	2.312	2.584	2.760
365,85	373,59	417,87	489,06	659,34	743,94	791,37	831,60	864,54	907,92	1.011,15	1.100,79	1.373,31	1.433,07
1.062	1.125	1.215	1.323	1.620	1.782	1.917	1.980	2.106	2.178	2.304	2.601	2.907	3.105
406,50	415,10	464,30	543,40	732,60	826,60	879,30	924,00	960,60	1.008,80	1.123,50	1.223,10	1.525,90	1.592,30
1.180	1.250	1.350	1.470	1.800	1.980	2.130	2.200	2.340	2.420	2.560	2.890	3.230	3.450
447,15	456,61	510,73	597,74	805,86	909,26	967,23	1.016,40	1.056,66	1.109,68	1.235,85	1.345,41	1.678,49	1.751,53
1.298	1.375	1.485	1.617	1.980	2.178	2.343	2.420	2.574	2.662	2.816	3.179	3.553	3.795
487,80	498,12	557,16	652,08	879,12	991,92	1.055,16	1.108,80	1.152,72	1.210,56	1.348,20	1.467,72	1.831,08	1.910,76
1.416	1.500	1.620	1.764	2.160	2.376	2.556	2.640	2.808	2.904	3.072	3.468	3.876	4.140
528,45	539,63	603,59	706,42	952,38	1.074,58	1.143,09	1.201,20	1.248,78	1.311,44	1.460,55	1.590,03	1.983,67	2.069,99
1.534	1.625	1.755	1.911	2.340	2.574	2.769	2.860	3.042	3.146	3.328	3.757	4.199	4.485
569,10	581,14	650,02	760,76	1.025,64	1.157,24	1.231,02	1.293,60	1.344,84	1.412,32	1.572,90	1.712,34	2.136,26	2.229,22
1.652	1.750	1.890	2.058	2.520	2.772	2.982	3.080	3.276	3.388	3.584	4.046	4.522	4.830
609,75	622,65	696,45	815,10	1.098,90	1.239,90	1.318,95	1.386,00	1.440,90	1.513,20	1.685,25	1.834,65	2.288,85	2.388,45
1.770	1.875	2.025	2.205	2.700	2.970	3.195	3.300	3.510	3.630	3.840	4.335	4.845	5.175
650,40	664,16	742,88	869,44	1.172,16	1.322,56	1.406,88	1.478,40	1.536,96	1.614,08	1.797,60	1.956,96	2.441,44	2.547,68
1.888	2.000	2.160	2.352	2.880	3.168	3.408	3.520	3.744	3.872	4.096	4.624	5.168	5.520
691,05	705,67	789,31	923,78	1.245,42	1.405,22	1.494,81	1.570,80	1.633,02	1.714,96	1.909,95	2.079,27	2.594,03	2.706,91
2.006	2.125	2.295	2.499	3.060	3.366	3.621	3.740	3.978	4.114	4.352	4.913	5.491	5.865
731,70	747,18	835,74	978,12	1.318,68	1.487,88	1.582,74	1.663,20	1.729,08	1.815,84	2.022,30	2.201,58	2.746,62	2.866,14
2.124	2.250	2.430	2.646	3.240	3.564	3.834	3.960	4.212	4.356	4.608	5.202	5.814	6.210
772,35	788,69	882,17	1.032,46	1.391,94	1.570,54	1.670,67	1.755,60	1.825,14	1.916,72	2.134,65	2.323,89	2.899,21	3.025,37
2.242	2.375	2.565	2.793	3.420	3.762	4.047	4.180	4.446	4.598	4.864	5.491	6.137	6.555
813,00	830,20	928,60	1.086,80	1.465,20	1.653,20	1.758,60	1.848,00	1.921,20	2.017,60	2.247,00	2.446,20	3.051,80	3.184,60
2.360	2.500	2.700	2.940	3.600	3.960	4.260	4.400	4.680	4.840	5.120	5.780	6.460	6.900
853,65	871,71	975,03	1.141,14	1.538,46	1.735,86	1.846,53	1.940,40	2.017,26	2.118,48	2.359,35	2.568,51	3.204,39	3.343,83
2.478	2.625	2.835	3.087	3.780	4.158	4.473	4.620	4.914	5.082	5.376	6.069	6.783	7.245
894,30	913,22	1.021,46	1.195,48	1.611,72	1.818,52	1.934,46	2.032,80	2.113,32	2.219,36	2.471,70	2.690,82	3.356,98	3.503,06
2.596	2.750	2.970	3.234	3.960	4.356	4.686	4.840	5.148	5.324	5.632	6.358	7.106	7.590
934,95	954,73	1.067,89	1.249,82	1.684,98	1.901,18	2.022,39	2.125,20	2.209,38	2.320,24	2.584,05	2.813,13	3.509,57	3.662,29
2.714	2.875	3.105	3.381	4.140	4.554	4.899	5.060	5.382	5.566	5.888	6.647	7.429	7.935
975,60	996,24	1.114,32	1.304,16	1.758,24	1.983,84	2.110,32	2.217,60	2.305,44	2.421,12	2.696,40	2.935,44	3.662,16	3.821,52
2.832	3.000	3.240	3.528	4.320	4.752	5.112	5.280	5.616	5.808	6.144	6.936	7.752	8.280
1.016,25	1.037,75	1.160,75	1.358,50	1.831,50	2.066,50	2.198,25	2.310,00	2.401,50	2.522,00	2.808,75	3.057,75	3.814,75	3.980,75
2.950	3.125	3.375	3.675	4.500	4.950	5.325	5.500	5.850	6.050	6.400	7.225	8.075	8.625
1.056,90	1.079,26	1.207,18	1.412,84	1.904,76	2.149,16	2.286,18	2.402,40	2.497,56	2.622,88	2.921,10	3.180,06	3.967,34	4.139,98
3.068	3.250	3.510	3.822	4.680	5.148	5.538	5.720	6.084	6.292	6.656	7.514	8.398	8.970
1.097,55	1.120,77	1.253,61	1.467,18	1.978,02	2.231,82	2.374,11	2.494,80	2.593,62	2.723,76	3.033,45	3.302,37	4.119,93	4.299,21
3.186	3.375	3.645	3.969	4.860	5.346	5.751	5.940	6.318	6.534	6.912	7.803	8.721	9.315
1.138,20	1.162,28	1.300,04	1.521,52	2.051,28	2.314,48	2.462,04	2.587,20	2.689,68	2.824,64	3.145,80	3.424,68	4.272,52	4.458,44
3.304	3.500	3.780	4.116	5.040	5.544	5.964	6.160	6.552	6.776	7.168	8.092	9.044	9.660
1.178,85	1.203,79	1.346,47	1.575,86	2.124,54	2.397,14	2.549,97	2.679,60	2.785,74	2.925,52	3.258,15	3.546,99	4.425,11	4.617,67
3.422	3.625	3.915	4.263	5.220	5.742	6.177	6.380	6.786	7.018	7.424	8.381	9.367	10.005
1.219,50	1.245,30	1.392,90	1.630,20	2.197,80	2.479,80	2.637,90	2.772,00	2.881,80	3.026,40	3.370,50	3.669,30	4.577,70	4.776,90
3.540	3.750	4.050	4.410	5.400	5.940	6.390	6.600	7.020	7.260	7.680	8.670	9.690	10.350

Classe di sconto: F0

Zehnder Charleston

MODELLO A 5 COLONNE

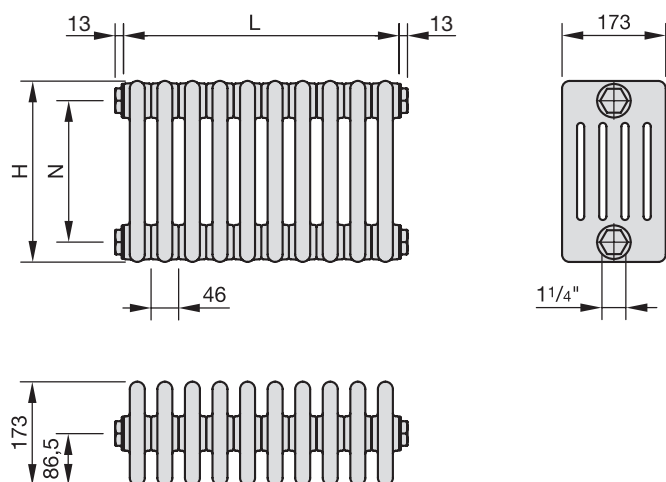

- H = altezza
 L = lunghezza = elementi x 46 mm
 N = interasse = H - 66 mm
 T = profondità
 V = contenuto d'acqua
 M = peso
 S_k = quota di irraggiamento
 q_{ms} = portata nominale
 n = esponente
 Φ_s = potenza termica nominale secondo
 EN 442 (75/65/20 °C) ΔT 50
 Φ = potenza termica con temperature del sistema ΔT 30

Quote in mm

Dati tecnici per elemento

Modello	H	N	T	V	M	S_k	q_{ms}	Esp.	$\Phi_s = \Delta T$ 50	$\Phi = \Delta T$ 30	Prezzo ad
	mm	mm	mm	dm ³	kg	%	kg/h	n	EN442	55/45/20 °C	elemento
									Watt	Watt	€
5026	260	194	173	0,8	0,88	17	4,0	1,28	45,1	23,5	36,86
5030	300	234	173	0,9	1,01	16	4,0	1,28	51,7	26,9	39,91
5035	350	284	173	1,0	1,18	15	5,0	1,28	59,9	31,2	39,91
5040	400	334	173	1,1	1,51	15	6,0	1,28	67,9	35,3	40,04
5045	450	384	173	1,2	1,67	14	7,0	1,27	75,8	39,6	40,15
5050	500	434	173	1,3	1,83	14	7,0	1,27	83,5	43,6	40,52
5055	550	484	173	1,3	2,00	14	8,0	1,27	91,1	47,6	41,62
5057	566	500	173	1,4	2,05	14	8,1	1,27	93,5	48,9	43,46
5060	600	534	173	1,5	2,16	13	8,0	1,27	98,6	51,5	44,45
5067	666	600	173	1,6	2,37	13	9,3	1,26	108,0	56,7	46,03
5069	685	619	173	1,7	2,44	13	9,5	1,26	111,0	58,3	47,87
5075	750	684	173	1,8	2,65	13	10,0	1,26	120,0	63,0	48,85
5077	766	700	173	1,9	2,70	13	10,6	1,26	123,0	64,6	49,34
5087	866	800	173	2,0	3,03	13	11,8	1,26	136,0	71,5	52,40
5089	885	819	173	2,1	3,09	13	12,0	1,26	139,0	73,0	53,38
5090	900	834	173	2,1	3,14	13	12,0	1,25	141,0	74,5	54,60
5100	1000	934	173	2,3	3,47	13	13,0	1,25	154,0	81,3	57,42
5110	1100	1034	173	2,5	3,79	13	14,0	1,25	167,0	88,2	61,79
5120	1200	1134	173	2,7	4,12	13	15,0	1,31	179,0	91,7	69,36
5150	1500	1434	173	3,3	5,10	13	19,0	1,31	219,0	112,2	92,97
5180	1800	1734	173	3,9	6,08	13	22,0	1,32	259,0	132,0	112,11
5200	2000	1934	173	4,3	6,73	13	25,0	1,32	285,0	145,2	124,50
5220	2200	2134	173	4,7	7,39	13	27,0	1,32	312,0	159,0	138,15
5250	2500	2434	173	5,3	8,37	13	30,0	1,32	352,0	179,4	151,33
5280	2800	2734	173	5,9	9,35	13	34,0	1,33	392,0	198,7	187,32
5300	3000	2934	173	6,4	10,00	13	36,0	1,33	420,0	212,9	200,38

Zehnder Charleston Retrofit: modelli con interassi adatti alle sostituzioni

Prezzo nel colore bianco RAL 9016; Supplemento per i colori della cartella colori: + 25%

Ordini possibili a partire da 2 elementi.

Classe di sconto: F0

Zehnder Charleston

5 COLONNE		Modello	5026	5030	5035	5040	5045	5050	5055	5057	5060
		Interasse (mm)	194	234	284	334	384	434	484	500	534
		Altezza (mm)	260	300	350	400	450	500	550	566	600
Elementi	3	€	110,58	119,73	119,73	120,12	120,45	121,56	124,86	130,38	133,35
Lungh. (mm)	138	Watt	135	155	180	204	227	251	273	281	296
Elementi	4	€	147,44	159,64	159,64	160,16	160,60	162,08	166,48	173,84	177,80
Lungh. (mm)	184	Watt	180	207	240	272	303	334	364	374	394
Elementi	5	€	184,30	199,55	199,55	200,20	200,75	202,60	208,10	217,30	222,25
Lungh. (mm)	230	Watt	226	259	300	340	379	418	456	468	493
Elementi	6	€	221,16	239,46	239,46	240,24	240,90	243,12	249,72	260,76	266,70
Lungh. (mm)	276	Watt	271	310	359	407	455	501	547	561	592
Elementi	7	€	258,02	279,37	279,37	280,28	281,05	283,64	291,34	304,22	311,15
Lungh. (mm)	322	Watt	316	362	419	475	531	585	638	655	690
Elementi	8	€	294,88	319,28	319,28	320,32	321,20	324,16	332,96	347,68	355,60
Lungh. (mm)	368	Watt	361	414	479	543	606	668	729	748	789
Elementi	9	€	331,74	359,19	359,19	360,36	361,35	364,68	374,58	391,14	400,05
Lungh. (mm)	414	Watt	406	465	539	611	682	752	820	842	887
Elementi	10	€	368,60	399,10	399,10	400,40	401,50	405,20	416,20	434,60	444,50
Lungh. (mm)	460	Watt	451	517	599	679	758	835	911	935	986
Elementi	11	€	405,46	439,01	439,01	440,44	441,65	445,72	457,82	478,06	488,95
Lungh. (mm)	506	Watt	496	569	659	747	834	919	1.002	1.029	1.085
Elementi	12	€	442,32	478,92	478,92	480,48	481,80	486,24	499,44	521,52	533,40
Lungh. (mm)	552	Watt	541	620	719	815	910	1.002	1.093	1.122	1.183
Elementi	13	€	479,18	518,83	518,83	520,52	521,95	526,76	541,06	564,98	577,85
Lungh. (mm)	598	Watt	586	672	779	883	985	1.086	1.184	1.216	1.282
Elementi	14	€	516,04	558,74	558,74	560,56	562,10	567,28	582,68	608,44	622,30
Lungh. (mm)	644	Watt	631	724	839	951	1.061	1.169	1.275	1.309	1.380
Elementi	15	€	552,90	598,65	598,65	600,60	602,25	607,80	624,30	651,90	666,75
Lungh. (mm)	690	Watt	677	776	899	1.019	1.137	1.253	1.367	1.403	1.479
Elementi	16	€	589,76	638,56	638,56	640,64	642,40	648,32	665,92	695,36	711,20
Lungh. (mm)	736	Watt	722	827	958	1.086	1.213	1.336	1.458	1.496	1.578
Elementi	17	€	626,62	678,47	678,47	680,68	682,55	688,84	707,54	738,82	755,65
Lungh. (mm)	782	Watt	767	879	1.018	1.154	1.289	1.420	1.549	1.590	1.676
Elementi	18	€	663,48	718,38	718,38	720,72	722,70	729,36	749,16	782,28	800,10
Lungh. (mm)	828	Watt	812	931	1.078	1.222	1.364	1.503	1.640	1.683	1.775
Elementi	19	€	700,34	758,29	758,29	760,76	762,85	769,88	790,78	825,74	844,55
Lungh. (mm)	874	Watt	857	982	1.138	1.290	1.440	1.587	1.731	1.777	1.873
Elementi	20	€	737,20	798,20	798,20	800,80	803,00	810,40	832,40	869,20	889,00
Lungh. (mm)	920	Watt	902	1.034	1.198	1.358	1.516	1.670	1.822	1.870	1.972
Elementi	21	€	774,06	838,11	838,11	840,84	843,15	850,92	874,02	912,66	933,45
Lungh. (mm)	966	Watt	947	1.086	1.258	1.426	1.592	1.754	1.913	1.964	2.071
Elementi	22	€	810,92	878,02	878,02	880,88	883,30	891,44	915,64	956,12	977,90
Lungh. (mm)	1012	Watt	992	1.137	1.318	1.494	1.668	1.837	2.004	2.057	2.169
Elementi	23	€	847,78	917,93	917,93	920,92	923,45	931,96	957,26	999,58	1.022,35
Lungh. (mm)	1058	Watt	1.037	1.189	1.378	1.562	1.743	1.921	2.095	2.151	2.268
Elementi	24	€	884,64	957,84	957,84	960,96	963,60	972,48	998,88	1.043,04	1.066,80
Lungh. (mm)	1104	Watt	1.082	1.241	1.438	1.630	1.819	2.004	2.186	2.244	2.366
Elementi	25	€	921,50	997,75	997,75	1.001,00	1.003,75	1.013,00	1.040,50	1.086,50	1.111,25
Lungh. (mm)	1150	Watt	1.128	1.293	1.498	1.698	1.895	2.088	2.278	2.338	2.465
Elementi	26	€	958,36	1.037,66	1.037,66	1.041,04	1.043,90	1.053,52	1.082,12	1.129,96	1.155,70
Lungh. (mm)	1196	Watt	1.173	1.344	1.557	1.765	1.971	2.171	2.369	2.431	2.564
Elementi	27	€	995,22	1.077,57	1.077,57	1.081,08	1.084,05	1.094,04	1.123,74	1.173,42	1.200,15
Lungh. (mm)	1242	Watt	1.218	1.396	1.617	1.833	2.047	2.255	2.460	2.525	2.662
Elementi	28	€	1.032,08	1.117,48	1.117,48	1.121,12	1.124,20	1.134,56	1.165,36	1.216,88	1.244,60
Lungh. (mm)	1288	Watt	1.263	1.448	1.677	1.901	2.122	2.338	2.551	2.618	2.761
Elementi	29	€	1.068,94	1.157,39	1.157,39	1.161,16	1.164,35	1.175,08	1.206,98	1.260,34	1.289,05
Lungh. (mm)	1334	Watt	1.308	1.499	1.737	1.969	2.198	2.422	2.642	2.712	2.859
Elementi	30	€	1.105,80	1.197,30	1.197,30	1.201,20	1.204,50	1.215,60	1.248,60	1.303,80	1.333,50
Lungh. (mm)	1380	Watt	1.353	1.551	1.797	2.037	2.274	2.505	2.733	2.805	2.958

Classe di sconto: F0

Zehnder Charleston

		Modello	5067	5069	5075	5077	5087	5089	5090	5100	5110	5120
5 COLONNE		Interasse (mm)	600	619	684	700	800	819	834	934	1034	1134
		Altezza (mm)	666	685	750	766	866	885	900	1000	1100	1200
Elementi	3	€	138,09	143,61	146,55	148,02	157,20	160,14	163,80	172,26	185,37	208,08
Lungh. (mm)	138	Watt	324	333	360	369	408	417	423	462	501	537
Elementi	4	€	184,12	191,48	195,40	197,36	209,60	213,52	218,40	229,68	247,16	277,44
Lungh. (mm)	184	Watt	432	444	480	492	544	556	564	616	668	716
Elementi	5	€	230,15	239,35	244,25	246,70	262,00	266,90	273,00	287,10	308,95	346,80
Lungh. (mm)	230	Watt	540	555	600	615	680	695	705	770	835	895
Elementi	6	€	276,18	287,22	293,10	296,04	314,40	320,28	327,60	344,52	370,74	416,16
Lungh. (mm)	276	Watt	648	666	720	738	816	834	846	924	1.002	1.074
Elementi	7	€	322,21	335,09	341,95	345,38	366,80	373,66	382,20	401,94	432,53	485,52
Lungh. (mm)	322	Watt	756	777	840	861	952	973	987	1.078	1.169	1.253
Elementi	8	€	368,24	382,96	390,80	394,72	419,20	427,04	436,80	459,36	494,32	554,88
Lungh. (mm)	368	Watt	864	888	960	984	1.088	1.112	1.128	1.232	1.336	1.432
Elementi	9	€	414,27	430,83	439,65	444,06	471,60	480,42	491,40	516,78	556,11	624,24
Lungh. (mm)	414	Watt	972	999	1.080	1.107	1.224	1.251	1.269	1.386	1.503	1.611
Elementi	10	€	460,30	478,70	488,50	493,40	524,00	533,80	546,00	574,20	617,90	693,60
Lungh. (mm)	460	Watt	1.080	1.110	1.200	1.230	1.360	1.390	1.410	1.540	1.670	1.790
Elementi	11	€	506,33	526,57	537,35	542,74	576,40	587,18	600,60	631,62	679,69	762,96
Lungh. (mm)	506	Watt	1.188	1.221	1.320	1.353	1.496	1.529	1.551	1.694	1.837	1.969
Elementi	12	€	552,36	574,44	586,20	592,08	628,80	640,56	655,20	689,04	741,48	832,32
Lungh. (mm)	552	Watt	1.296	1.332	1.440	1.476	1.632	1.668	1.692	1.848	2.004	2.148
Elementi	13	€	598,39	622,31	635,05	641,42	681,20	693,94	709,80	746,46	803,27	901,68
Lungh. (mm)	598	Watt	1.404	1.443	1.560	1.599	1.768	1.807	1.833	2.002	2.171	2.327
Elementi	14	€	644,42	670,18	683,90	690,76	733,60	747,32	764,40	803,88	865,06	971,04
Lungh. (mm)	644	Watt	1.512	1.554	1.680	1.722	1.904	1.946	1.974	2.156	2.338	2.506
Elementi	15	€	690,45	718,05	732,75	740,10	786,00	800,70	819,00	861,30	926,85	1.040,40
Lungh. (mm)	690	Watt	1.620	1.665	1.800	1.845	2.040	2.085	2.115	2.310	2.505	2.685
Elementi	16	€	736,48	765,92	781,60	789,44	838,40	854,08	873,60	918,72	988,64	1.109,76
Lungh. (mm)	736	Watt	1.728	1.776	1.920	1.968	2.176	2.224	2.256	2.464	2.672	2.864
Elementi	17	€	782,51	813,79	830,45	838,78	890,80	907,46	928,20	976,14	1.050,43	1.179,12
Lungh. (mm)	782	Watt	1.836	1.887	2.040	2.091	2.312	2.363	2.397	2.618	2.839	3.043
Elementi	18	€	828,54	861,66	879,30	888,12	943,20	960,84	982,80	1.033,56	1.112,22	1.248,48
Lungh. (mm)	828	Watt	1.944	1.998	2.160	2.214	2.448	2.502	2.538	2.772	3.006	3.222
Elementi	19	€	874,57	909,53	928,15	937,46	995,60	1.014,22	1.037,40	1.090,98	1.174,01	1.317,84
Lungh. (mm)	874	Watt	2.052	2.109	2.280	2.337	2.584	2.641	2.679	2.926	3.173	3.401
Elementi	20	€	920,60	957,40	977,00	986,80	1.048,00	1.067,60	1.092,00	1.148,40	1.235,80	1.387,20
Lungh. (mm)	920	Watt	2.160	2.220	2.400	2.460	2.720	2.780	2.820	3.080	3.340	3.580
Elementi	21	€	966,63	1.005,27	1.025,85	1.036,14	1.100,40	1.120,98	1.146,60	1.205,82	1.297,59	1.456,56
Lungh. (mm)	966	Watt	2.268	2.331	2.520	2.583	2.856	2.919	2.961	3.234	3.507	3.759
Elementi	22	€	1.012,66	1.053,14	1.074,70	1.085,48	1.152,80	1.174,36	1.201,20	1.263,24	1.359,38	1.525,92
Lungh. (mm)	1012	Watt	2.376	2.442	2.640	2.706	2.992	3.058	3.102	3.388	3.674	3.938
Elementi	23	€	1.058,69	1.101,01	1.123,55	1.134,82	1.205,20	1.227,74	1.255,80	1.320,66	1.421,17	1.595,28
Lungh. (mm)	1058	Watt	2.484	2.553	2.760	2.829	3.128	3.197	3.243	3.542	3.841	4.117
Elementi	24	€	1.104,72	1.148,88	1.172,40	1.184,16	1.257,60	1.281,12	1.310,40	1.378,08	1.482,96	1.664,64
Lungh. (mm)	1104	Watt	2.592	2.664	2.880	2.952	3.264	3.336	3.384	3.696	4.008	4.296
Elementi	25	€	1.150,75	1.196,75	1.221,25	1.233,50	1.310,00	1.334,50	1.365,00	1.435,50	1.544,75	1.734,00
Lungh. (mm)	1150	Watt	2.700	2.775	3.000	3.075	3.400	3.475	3.525	3.850	4.175	4.475
Elementi	26	€	1.196,78	1.244,62	1.270,10	1.282,84	1.362,40	1.387,88	1.419,60	1.492,92	1.606,54	1.803,36
Lungh. (mm)	1196	Watt	2.808	2.886	3.120	3.198	3.536	3.614	3.666	4.004	4.342	4.654
Elementi	27	€	1.242,81	1.292,49	1.318,95	1.332,18	1.414,80	1.441,26	1.474,20	1.550,34	1.668,33	1.872,72
Lungh. (mm)	1242	Watt	2.916	2.997	3.240	3.321	3.672	3.753	3.807	4.158	4.509	4.833
Elementi	28	€	1.288,84	1.340,36	1.367,80	1.381,52	1.467,20	1.494,64	1.528,80	1.607,76	1.730,12	1.942,08
Lungh. (mm)	1288	Watt	3.024	3.108	3.360	3.444	3.808	3.892	3.948	4.312	4.676	5.012
Elementi	29	€	1.334,87	1.388,23	1.416,65	1.430,86	1.519,60	1.548,02	1.583,40	1.665,18	1.791,91	2.011,44
Lungh. (mm)	1334	Watt	3.132	3.219	3.480	3.567	3.944	4.031	4.089	4.466	4.843	5.191
Elementi	30	€	1.380,90	1.436,10	1.465,50	1.480,20	1.572,00	1.601,40	1.638,00	1.722,60	1.853,70	2.080,80
Lungh. (mm)	1380	Watt	3.240	3.330	3.600	3.690	4.080	4.170	4.230	4.620	5.010	5.370

Classe di sconto: F0

Zehnder Charleston

5 COLONNE		Modello	5150	5180	5200	5220	5250	5280	5300
		Interasse (mm)	1434	1734	1934	2134	2434	2734	2934
		Altezza (mm)	1500	1800	2000	2200	2500	2800	3000
Elementi	3	€	278,91	336,33	373,50	414,45	453,99	561,96	601,14
Lungh. (mm)	46	Watt	657	777	855	936	1.056	1.176	1.260
Elementi	4	€	371,88	448,44	498,00	552,60	605,32	749,28	801,52
Lungh. (mm)	184	Watt	876	1.036	1.140	1.248	1.408	1.568	1.680
Elementi	5	€	464,85	560,55	622,50	690,75	756,65	936,60	1.001,90
Lungh. (mm)	230	Watt	1.095	1.295	1.425	1.560	1.760	1.960	2.100
Elementi	6	€	557,82	672,66	747,00	828,90	907,98	1.123,92	1.202,28
Lungh. (mm)	276	Watt	1.314	1.554	1.710	1.872	2.112	2.352	2.520
Elementi	7	€	650,79	784,77	871,50	967,05	1.059,31	1.311,24	1.402,66
Lungh. (mm)	322	Watt	1.533	1.813	1.995	2.184	2.464	2.744	2.940
Elementi	8	€	743,76	896,88	996,00	1.105,20	1.210,64	1.498,56	1.603,04
Lungh. (mm)	368	Watt	1.752	2.072	2.280	2.496	2.816	3.136	3.360
Elementi	9	€	836,73	1.008,99	1.120,50	1.243,35	1.361,97	1.685,88	1.803,42
Lungh. (mm)	414	Watt	1.971	2.331	2.565	2.808	3.168	3.528	3.780
Elementi	10	€	929,70	1.121,10	1.245,00	1.381,50	1.513,30	1.873,20	2.003,80
Lungh. (mm)	460	Watt	2.190	2.590	2.850	3.120	3.520	3.920	4.200
Elementi	11	€	1.022,67	1.233,21	1.369,50	1.519,65	1.664,63	2.060,52	2.204,18
Lungh. (mm)	506	Watt	2.409	2.849	3.135	3.432	3.872	4.312	4.620
Elementi	12	€	1.115,64	1.345,32	1.494,00	1.657,80	1.815,96	2.247,84	2.404,56
Lungh. (mm)	552	Watt	2.628	3.108	3.420	3.744	4.224	4.704	5.040
Elementi	13	€	1.208,61	1.457,43	1.618,50	1.795,95	1.967,29	2.435,16	2.604,94
Lungh. (mm)	598	Watt	2.847	3.367	3.705	4.056	4.576	5.096	5.460
Elementi	14	€	1.301,58	1.569,54	1.743,00	1.934,10	2.118,62	2.622,48	2.805,32
Lungh. (mm)	644	Watt	3.066	3.626	3.990	4.368	4.928	5.488	5.880
Elementi	15	€	1.394,55	1.681,65	1.867,50	2.072,25	2.269,95	2.809,80	3.005,70
Lungh. (mm)	690	Watt	3.285	3.885	4.275	4.680	5.280	5.880	6.300
Elementi	16	€	1.487,52	1.793,76	1.992,00	2.210,40	2.421,28	2.997,12	3.206,08
Lungh. (mm)	736	Watt	3.504	4.144	4.560	4.992	5.632	6.272	6.720
Elementi	17	€	1.580,49	1.905,87	2.116,50	2.348,55	2.572,61	3.184,44	3.406,46
Lungh. (mm)	782	Watt	3.723	4.403	4.845	5.304	5.984	6.664	7.140
Elementi	18	€	1.673,46	2.017,98	2.241,00	2.486,70	2.723,94	3.371,76	3.606,84
Lungh. (mm)	828	Watt	3.942	4.662	5.130	5.616	6.336	7.056	7.560
Elementi	19	€	1.766,43	2.130,09	2.365,50	2.624,85	2.875,27	3.559,08	3.807,22
Lungh. (mm)	874	Watt	4.161	4.921	5.415	5.928	6.688	7.448	7.980
Elementi	20	€	1.859,40	2.242,20	2.490,00	2.763,00	3.026,60	3.746,40	4.007,60
Lungh. (mm)	920	Watt	4.380	5.180	5.700	6.240	7.040	7.840	8.400
Elementi	21	€	1.952,37	2.354,31	2.614,50	2.901,15	3.177,93	3.933,72	4.207,98
Lungh. (mm)	966	Watt	4.599	5.439	5.985	6.552	7.392	8.232	8.820
Elementi	22	€	2.045,34	2.466,42	2.739,00	3.039,30	3.329,26	4.121,04	4.408,36
Lungh. (mm)	1012	Watt	4.818	5.698	6.270	6.864	7.744	8.624	9.240
Elementi	23	€	2.138,31	2.578,53	2.863,50	3.177,45	3.480,59	4.308,36	4.608,74
Lungh. (mm)	1058	Watt	5.037	5.957	6.555	7.176	8.096	9.016	9.660
Elementi	24	€	2.231,28	2.690,64	2.988,00	3.315,60	3.631,92	4.495,68	4.809,12
Lungh. (mm)	1104	Watt	5.256	6.216	6.840	7.488	8.448	9.408	10.080
Elementi	25	€	2.324,25	2.802,75	3.112,50	3.453,75	3.783,25	4.683,00	5.009,50
Lungh. (mm)	1150	Watt	5.475	6.475	7.125	7.800	8.800	9.800	10.500
Elementi	26	€	2.417,22	2.914,86	3.237,00	3.591,90	3.934,58	4.870,32	5.209,88
Lungh. (mm)	1196	Watt	5.694	6.734	7.410	8.112	9.152	10.192	10.920
Elementi	27	€	2.510,19	3.026,97	3.361,50	3.730,05	4.085,91	5.057,64	5.410,26
Lungh. (mm)	1242	Watt	5.913	6.993	7.695	8.424	9.504	10.584	11.340
Elementi	28	€	2.603,16	3.139,08	3.486,00	3.868,20	4.237,24	5.244,96	5.610,64
Lungh. (mm)	1288	Watt	6.132	7.252	7.980	8.736	9.856	10.976	11.760
Elementi	29	€	2.696,13	3.251,19	3.610,50	4.006,35	4.388,57	5.432,28	5.811,02
Lungh. (mm)	1334	Watt	6.351	7.511	8.265	9.048	10.208	11.368	12.180
Elementi	30	€	2.789,10	3.363,30	3.735,00	4.144,50	4.539,90	5.619,60	6.011,40
Lungh. (mm)	1380	Watt	6.570	7.770	8.550	9.360	10.560	11.760	12.600

Classe di sconto: F0

Zehnder Charleston

MODELLO A 6 COLONNE

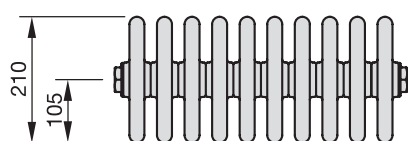
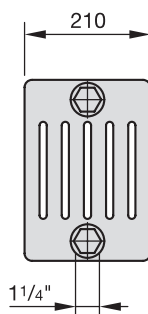
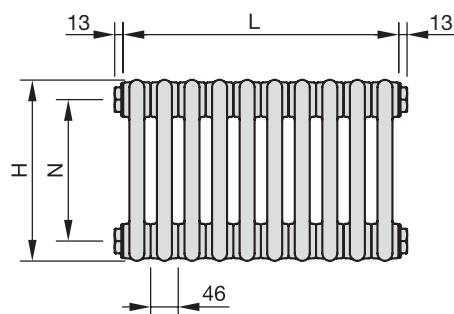

- H = altezza
 L = lunghezza = elementi x 46 mm
 N = interasse = H - 66 mm
 T = profondità
 V = contenuto d'acqua
 M = peso
 s_k = quota di irraggiamento
 q_{ms} = portata nominale
 n = esponente
 Φ_s = potenza termica nominale secondo EN 442 (75/65/20 °C) ΔT 50
 Φ = potenza termica con temperature del sistema ΔT 30

Quote in mm

Dati tecnici per elemento

Modello	H mm	N mm	T mm	V dm ³	M kg	s_k %	q_{ms} kg/h	Esp. n	$\Phi_s = \Delta T$ 50 EN442 Watt	$\Phi = \Delta T$ 30 55/45/20 °C Watt	Prezzo ad elemento €
6026	260	194	210	1,0	1,26	18	5,0	1,28	53,5	27,8	42,98
6030	300	234	210	1,1	1,42	15	5,0	1,28	61,3	31,9	48,00
6035	350	284	210	1,2	1,62	14	6,0	1,28	71,0	36,9	48,00
6040	400	334	210	1,3	1,79	14	7,0	1,28	80,5	41,9	48,24
6045	450	384	210	1,4	1,99	13	8,0	1,27	89,8	46,9	48,36
6050	500	434	210	1,5	2,19	13	9,0	1,27	99,0	51,7	48,48
6055	550	484	210	1,6	2,38	12	9,0	1,27	108,0	56,5	48,48
6057	566	500	210	1,7	2,45	12	9,5	1,27	111,0	58,0	51,05
6060	600	534	210	1,8	2,58	12	10,0	1,27	117,0	61,2	51,54
6067	666	600	210	1,9	2,84	12	11,1	1,26	128,0	67,2	55,70
6069	685	619	210	2,0	2,92	12	11,4	1,26	132,0	69,3	57,30
6075	750	684	210	2,1	3,17	12	12,0	1,26	143,0	75,1	58,40
6077	766	700	210	2,2	3,23	12	12,6	1,26	147,0	77,2	60,72
6087	866	800	210	2,4	3,63	12	13,9	1,26	162,0	85,1	67,34
6089	885	819	210	2,5	3,70	12	14,2	1,26	165,0	86,7	68,57
6090	900	834	210	2,5	3,76	12	14,0	1,25	167,0	88,2	70,15
6100	1000	934	210	2,7	4,16	12	16,0	1,25	183,0	96,6	71,13
6110	1100	1034	210	3,0	4,55	12	17,0	1,25	198,0	104,6	74,75
6120	1200	1134	210	3,2	4,95	12	18,0	1,31	210,0	107,5	87,36
6150	1500	1434	210	4,0	6,13	12	22,0	1,31	256,0	131,1	114,41
6180	1800	1734	210	4,7	7,31	12	26,0	1,32	303,0	154,4	137,11
6200	2000	1934	210	5,2	8,10	12	29,0	1,32	334,0	170,2	151,78
6220	2200	2134	210	5,6	8,89	12	31,0	1,32	365,0	186,0	165,20
6250	2500	2434	210	6,3	10,07	12	35,0	1,32	412,0	209,9	184,22
6280	2800	2734	210	7,0	11,25	12	39,0	1,33	459,0	232,7	227,09
6300	3000	2934	210	7,5	12,04	12	42,0	1,33	491,0	248,9	241,66

Zehnder Charleston Retrofit: modelli con interassi adatti alle sostituzioni

Prezzo nel colore bianco RAL 9016; Supplemento per i colori della cartella colori: + 25%
 Ordini possibili a partire da 2 elementi.

Classe di sconto: F0

Zehnder Charleston

6 COLONNE		Modello	6026	6030	6035	6040	6045	6050	6055	6057	6060
		Interasse (mm)	194	234	284	334	384	434	484	500	534
		Altezza (mm)	260	300	350	400	450	500	550	566	600
Elementi	3	€	128,94	144,00	144,00	144,72	145,08	145,44	145,44	153,15	154,62
Lungh. (mm)	138	Watt	161	184	213	242	269	297	324	333	351
Elementi	4	€	171,92	192,00	192,00	192,96	193,44	193,92	193,92	204,20	206,16
Lungh. (mm)	184	Watt	214	245	284	322	359	396	432	444	468
Elementi	5	€	214,90	240,00	240,00	241,20	241,80	242,40	242,40	255,25	257,70
Lungh. (mm)	230	Watt	268	307	355	403	449	495	540	555	585
Elementi	6	€	257,88	288,00	288,00	289,44	290,16	290,88	290,88	306,30	309,24
Lungh. (mm)	276	Watt	321	368	426	483	539	594	648	666	702
Elementi	7	€	300,86	336,00	336,00	337,68	338,52	339,36	339,36	357,35	360,78
Lungh. (mm)	322	Watt	375	429	497	564	629	693	756	777	819
Elementi	8	€	343,84	384,00	384,00	385,92	386,88	387,84	387,84	408,40	412,32
Lungh. (mm)	368	Watt	428	490	568	644	718	792	864	888	936
Elementi	9	€	386,82	432,00	432,00	434,16	435,24	436,32	436,32	459,45	463,86
Lungh. (mm)	414	Watt	482	552	639	725	808	891	972	999	1.053
Elementi	10	€	429,80	480,00	480,00	482,40	483,60	484,80	484,80	510,50	515,40
Lungh. (mm)	460	Watt	535	613	710	805	898	990	1.080	1.110	1.170
Elementi	11	€	472,78	528,00	528,00	530,64	531,96	533,28	533,28	561,55	566,94
Lungh. (mm)	506	Watt	589	674	781	886	988	1.089	1.188	1.221	1.287
Elementi	12	€	515,76	576,00	576,00	578,88	580,32	581,76	581,76	612,60	618,48
Lungh. (mm)	552	Watt	642	736	852	966	1.078	1.188	1.296	1.332	1.404
Elementi	13	€	558,74	624,00	624,00	627,12	628,68	630,24	630,24	663,65	670,02
Lungh. (mm)	598	Watt	696	797	923	1.047	1.167	1.287	1.404	1.443	1.521
Elementi	14	€	601,72	672,00	672,00	675,36	677,04	678,72	678,72	714,70	721,56
Lungh. (mm)	644	Watt	749	858	994	1.127	1.257	1.386	1.512	1.554	1.638
Elementi	15	€	644,70	720,00	720,00	723,60	725,40	727,20	727,20	765,75	773,10
Lungh. (mm)	690	Watt	803	920	1.065	1.208	1.347	1.485	1.620	1.665	1.755
Elementi	16	€	687,68	768,00	768,00	771,84	773,76	775,68	775,68	816,80	824,64
Lungh. (mm)	736	Watt	856	981	1.136	1.288	1.437	1.584	1.728	1.776	1.872
Elementi	17	€	730,66	816,00	816,00	820,08	822,12	824,16	824,16	867,85	876,18
Lungh. (mm)	782	Watt	910	1.042	1.207	1.369	1.527	1.683	1.836	1.887	1.989
Elementi	18	€	773,64	864,00	864,00	868,32	870,48	872,64	872,64	918,90	927,72
Lungh. (mm)	828	Watt	963	1.103	1.278	1.449	1.616	1.782	1.944	1.998	2.106
Elementi	19	€	816,62	912,00	912,00	916,56	918,84	921,12	921,12	969,95	979,26
Lungh. (mm)	874	Watt	1.017	1.165	1.349	1.530	1.706	1.881	2.052	2.109	2.223
Elementi	20	€	859,60	960,00	960,00	964,80	967,20	969,60	969,60	1.021,00	1.030,80
Lungh. (mm)	920	Watt	1.070	1.226	1.420	1.610	1.796	1.980	2.160	2.220	2.340
Elementi	21	€	902,58	1.008,00	1.008,00	1.013,04	1.015,56	1.018,08	1.018,08	1.072,05	1.082,34
Lungh. (mm)	966	Watt	1.124	1.287	1.491	1.691	1.886	2.079	2.268	2.331	2.457
Elementi	22	€	945,56	1.056,00	1.056,00	1.061,28	1.063,92	1.066,56	1.066,56	1.123,10	1.133,88
Lungh. (mm)	1012	Watt	1.177	1.349	1.562	1.771	1.976	2.178	2.376	2.442	2.574
Elementi	23	€	988,54	1.104,00	1.104,00	1.109,52	1.112,28	1.115,04	1.115,04	1.174,15	1.185,42
Lungh. (mm)	1058	Watt	1.231	1.410	1.633	1.852	2.065	2.277	2.484	2.553	2.691
Elementi	24	€	1.031,52	1.152,00	1.152,00	1.157,76	1.160,64	1.163,52	1.163,52	1.225,20	1.236,96
Lungh. (mm)	1104	Watt	1.284	1.471	1.704	1.932	2.155	2.376	2.592	2.664	2.808
Elementi	25	€	1.074,50	1.200,00	1.200,00	1.206,00	1.209,00	1.212,00	1.212,00	1.276,25	1.288,50
Lungh. (mm)	1150	Watt	1.338	1.533	1.775	2.013	2.245	2.475	2.700	2.775	2.925
Elementi	26	€	1.117,48	1.248,00	1.248,00	1.254,24	1.257,36	1.260,48	1.260,48	1.327,30	1.340,04
Lungh. (mm)	1196	Watt	1.391	1.594	1.846	2.093	2.335	2.574	2.808	2.886	3.042
Elementi	27	€	1.160,46	1.296,00	1.296,00	1.302,48	1.305,72	1.308,96	1.308,96	1.378,35	1.391,58
Lungh. (mm)	1242	Watt	1.445	1.655	1.917	2.174	2.425	2.673	2.916	2.997	3.159
Elementi	28	€	1.203,44	1.344,00	1.344,00	1.350,72	1.354,08	1.357,44	1.357,44	1.429,40	1.443,12
Lungh. (mm)	1288	Watt	1.498	1.716	1.988	2.254	2.514	2.772	3.024	3.108	3.276
Elementi	29	€	1.246,42	1.392,00	1.392,00	1.398,96	1.402,44	1.405,92	1.405,92	1.480,45	1.494,66
Lungh. (mm)	1334	Watt	1.552	1.778	2.059	2.335	2.604	2.871	3.132	3.219	3.393
Elementi	30	€	1.289,40	1.440,00	1.440,00	1.447,20	1.450,80	1.454,40	1.454,40	1.531,50	1.546,20
Lungh. (mm)	1380	Watt	1.605	1.839	2.130	2.415	2.694	2.970	3.240	3.330	3.510

Classe di sconto: F0

Zehnder Charleston

		Modello	6067	6069	6075	6077	6087	6089	6090	6100	6110	6120
6 COLONNE		Interasse (mm)	600	619	684	700	800	819	834	934	1034	1134
		Altezza (mm)	666	685	750	766	866	885	900	1000	1100	1200
Elementi	3	€	167,10	171,90	175,20	182,16	202,02	205,71	210,45	213,39	224,25	262,08
Lungh. (mm)	138	Watt	384	396	429	441	486	495	501	549	594	630
Elementi	4	€	222,80	229,20	233,60	242,88	269,36	274,28	280,60	284,52	299,00	349,44
Lungh. (mm)	184	Watt	512	528	572	588	648	660	668	732	792	840
Elementi	5	€	278,50	286,50	292,00	303,60	336,70	342,85	350,75	355,65	373,75	436,80
Lungh. (mm)	230	Watt	640	660	715	735	810	825	835	915	990	1.050
Elementi	6	€	334,20	343,80	350,40	364,32	404,04	411,42	420,90	426,78	448,50	524,16
Lungh. (mm)	276	Watt	768	792	858	882	972	990	1.002	1.098	1.188	1.260
Elementi	7	€	389,90	401,10	408,80	425,04	471,38	479,99	491,05	497,91	523,25	611,52
Lungh. (mm)	322	Watt	896	924	1.001	1.029	1.134	1.155	1.169	1.281	1.386	1.470
Elementi	8	€	445,60	458,40	467,20	485,76	538,72	548,56	561,20	569,04	598,00	698,88
Lungh. (mm)	368	Watt	1.024	1.056	1.144	1.176	1.296	1.320	1.336	1.464	1.584	1.680
Elementi	9	€	501,30	515,70	525,60	546,48	606,06	617,13	631,35	640,17	672,75	786,24
Lungh. (mm)	414	Watt	1.152	1.188	1.287	1.323	1.458	1.485	1.503	1.647	1.782	1.890
Elementi	10	€	557,00	573,00	584,00	607,20	673,40	685,70	701,50	711,30	747,50	873,60
Lungh. (mm)	460	Watt	1.280	1.320	1.430	1.470	1.620	1.650	1.670	1.830	1.980	2.100
Elementi	11	€	612,70	630,30	642,40	667,92	740,74	754,27	771,65	782,43	822,25	960,96
Lungh. (mm)	506	Watt	1.408	1.452	1.573	1.617	1.782	1.815	1.837	2.013	2.178	2.310
Elementi	12	€	668,40	687,60	700,80	728,64	808,08	822,84	841,80	853,56	897,00	1.048,32
Lungh. (mm)	552	Watt	1.536	1.584	1.716	1.764	1.944	1.980	2.004	2.196	2.376	2.520
Elementi	13	€	724,10	744,90	759,20	789,36	875,42	891,41	911,95	924,69	971,75	1.135,68
Lungh. (mm)	598	Watt	1.664	1.716	1.859	1.911	2.106	2.145	2.171	2.379	2.574	2.730
Elementi	14	€	779,80	802,20	817,60	850,08	942,76	959,98	982,10	995,82	1.046,50	1.223,04
Lungh. (mm)	644	Watt	1.792	1.848	2.002	2.058	2.268	2.310	2.338	2.562	2.772	2.940
Elementi	15	€	835,50	859,50	876,00	910,80	1.010,10	1.028,55	1.052,25	1.066,95	1.121,25	1.310,40
Lungh. (mm)	690	Watt	1.920	1.980	2.145	2.205	2.430	2.475	2.505	2.745	2.970	3.150
Elementi	16	€	891,20	916,80	934,40	971,52	1.077,44	1.097,12	1.122,40	1.138,08	1.196,00	1.397,76
Lungh. (mm)	736	Watt	2.048	2.112	2.288	2.352	2.592	2.640	2.672	2.928	3.168	3.360
Elementi	17	€	946,90	974,10	992,80	1.032,24	1.144,78	1.165,69	1.192,55	1.209,21	1.270,75	1.485,12
Lungh. (mm)	782	Watt	2.176	2.244	2.431	2.499	2.754	2.805	2.839	3.111	3.366	3.570
Elementi	18	€	1.002,60	1.031,40	1.051,20	1.092,96	1.212,12	1.234,26	1.262,70	1.280,34	1.345,50	1.572,48
Lungh. (mm)	828	Watt	2.304	2.376	2.574	2.646	2.916	2.970	3.006	3.294	3.564	3.780
Elementi	19	€	1.058,30	1.088,70	1.109,60	1.153,68	1.279,46	1.302,83	1.332,85	1.351,47	1.420,25	1.659,84
Lungh. (mm)	874	Watt	2.432	2.508	2.717	2.793	3.078	3.135	3.173	3.477	3.762	3.990
Elementi	20	€	1.114,00	1.146,00	1.168,00	1.214,40	1.346,80	1.371,40	1.403,00	1.422,60	1.495,00	1.747,20
Lungh. (mm)	920	Watt	2.560	2.640	2.860	2.940	3.240	3.300	3.340	3.660	3.960	4.200
Elementi	21	€	1.169,70	1.203,30	1.226,40	1.275,12	1.414,14	1.439,97	1.473,15	1.493,73	1.569,75	1.834,56
Lungh. (mm)	966	Watt	2.688	2.772	3.003	3.087	3.402	3.465	3.507	3.843	4.158	4.410
Elementi	22	€	1.225,40	1.260,60	1.284,80	1.335,84	1.481,48	1.508,54	1.543,30	1.564,86	1.644,50	1.921,92
Lungh. (mm)	1012	Watt	2.816	2.904	3.146	3.234	3.564	3.630	3.674	4.026	4.356	4.620
Elementi	23	€	1.281,10	1.317,90	1.343,20	1.396,56	1.548,82	1.577,11	1.613,45	1.635,99	1.719,25	2.009,28
Lungh. (mm)	1058	Watt	2.944	3.036	3.289	3.381	3.726	3.795	3.841	4.209	4.554	4.830
Elementi	24	€	1.336,80	1.375,20	1.401,60	1.457,28	1.616,16	1.645,68	1.683,60	1.707,12	1.794,00	2.096,64
Lungh. (mm)	1104	Watt	3.072	3.168	3.432	3.528	3.888	3.960	4.008	4.392	4.752	5.040
Elementi	25	€	1.392,50	1.432,50	1.460,00	1.518,00	1.683,50	1.714,25	1.753,75	1.778,25	1.868,75	2.184,00
Lungh. (mm)	1150	Watt	3.200	3.300	3.575	3.675	4.050	4.125	4.175	4.575	4.950	5.250
Elementi	26	€	1.448,20	1.489,80	1.518,40	1.578,72	1.750,84	1.782,82	1.823,90	1.849,38	1.943,50	2.271,36
Lungh. (mm)	1196	Watt	3.328	3.432	3.718	3.822	4.212	4.290	4.342	4.758	5.148	5.460
Elementi	27	€	1.503,90	1.547,10	1.576,80	1.639,44	1.818,18	1.851,39	1.894,05	1.920,51	2.018,25	2.358,72
Lungh. (mm)	1242	Watt	3.456	3.564	3.861	3.969	4.374	4.455	4.509	4.941	5.346	5.670
Elementi	28	€	1.559,60	1.604,40	1.635,20	1.700,16	1.885,52	1.919,96	1.964,20	1.991,64	2.093,00	2.446,08
Lungh. (mm)	1288	Watt	3.584	3.696	4.004	4.116	4.536	4.620	4.676	5.124	5.544	5.880
Elementi	29	€	1.615,30	1.661,70	1.693,60	1.760,88	1.952,86	1.988,53	2.034,35	2.062,77	2.167,75	2.533,44
Lungh. (mm)	1334	Watt	3.712	3.828	4.147	4.263	4.698	4.785	4.843	5.307	5.742	6.090
Elementi	30	€	1.671,00	1.719,00	1.752,00	1.821,60	2.020,20	2.057,10	2.104,50	2.133,90	2.242,50	2.620,80
Lungh. (mm)	1380	Watt	3.840	3.960	4.290	4.410	4.860	4.950	5.010	5.490	5.940	6.300

Classe di sconto: F0

Zehnder Charleston

6 COLONNE		Modello	6150	6180	6200	6220	6250	6280	6300
		Interasse (mm)	1434	1734	1934	2134	2434	2734	2934
		Altezza (mm)	1500	1800	2000	2200	2500	2800	3000
Elementi	3	€	343,23	411,33	455,34	495,60	552,66	681,27	724,98
Lungh. (mm)	138	Watt	768	909	1.002	1.095	1.236	1.377	1.473
Elementi	4	€	457,64	548,44	607,12	660,80	736,88	908,36	966,64
Lungh. (mm)	184	Watt	1.024	1.212	1.336	1.460	1.648	1.836	1.964
Elementi	5	€	572,05	685,55	758,90	826,00	921,10	1.135,45	1.208,30
Lungh. (mm)	230	Watt	1.280	1.515	1.670	1.825	2.060	2.295	2.455
Elementi	6	€	686,46	822,66	910,68	991,20	1.105,32	1.362,54	1.449,96
Lungh. (mm)	276	Watt	1.536	1.818	2.004	2.190	2.472	2.754	2.946
Elementi	7	€	800,87	959,77	1.062,46	1.156,40	1.289,54	1.589,63	1.691,62
Lungh. (mm)	322	Watt	1.792	2.121	2.338	2.555	2.884	3.213	3.437
Elementi	8	€	915,28	1.096,88	1.214,24	1.321,60	1.473,76	1.816,72	1.933,28
Lungh. (mm)	368	Watt	2.048	2.424	2.672	2.920	3.296	3.672	3.928
Elementi	9	€	1.029,69	1.233,99	1.366,02	1.486,80	1.657,98	2.043,81	2.174,94
Lungh. (mm)	414	Watt	2.304	2.727	3.006	3.285	3.708	4.131	4.419
Elementi	10	€	1.144,10	1.371,10	1.517,80	1.652,00	1.842,20	2.270,90	2.416,60
Lungh. (mm)	460	Watt	2.560	3.030	3.340	3.650	4.120	4.590	4.910
Elementi	11	€	1.258,51	1.508,21	1.669,58	1.817,20	2.026,42	2.497,99	2.658,26
Lungh. (mm)	506	Watt	2.816	3.333	3.674	4.015	4.532	5.049	5.401
Elementi	12	€	1.372,92	1.645,32	1.821,36	1.982,40	2.210,64	2.725,08	2.899,92
Lungh. (mm)	552	Watt	3.072	3.636	4.008	4.380	4.944	5.508	5.892
Elementi	13	€	1.487,33	1.782,43	1.973,14	2.147,60	2.394,86	2.952,17	3.141,58
Lungh. (mm)	598	Watt	3.328	3.939	4.342	4.745	5.356	5.967	6.383
Elementi	14	€	1.601,74	1.919,54	2.124,92	2.312,80	2.579,08	3.179,26	3.383,24
Lungh. (mm)	644	Watt	3.584	4.242	4.676	5.110	5.768	6.426	6.874
Elementi	15	€	1.716,15	2.056,65	2.276,70	2.478,00	2.763,30	3.406,35	3.624,90
Lungh. (mm)	690	Watt	3.840	4.545	5.010	5.475	6.180	6.885	7.365
Elementi	16	€	1.830,56	2.193,76	2.428,48	2.643,20	2.947,52	3.633,44	3.866,56
Lungh. (mm)	736	Watt	4.096	4.848	5.344	5.840	6.592	7.344	7.856
Elementi	17	€	1.944,97	2.330,87	2.580,26	2.808,40	3.131,74	3.860,53	4.108,22
Lungh. (mm)	782	Watt	4.352	5.151	5.678	6.205	7.004	7.803	8.347
Elementi	18	€	2.059,38	2.467,98	2.732,04	2.973,60	3.315,96	4.087,62	4.349,88
Lungh. (mm)	828	Watt	4.608	5.454	6.012	6.570	7.416	8.262	8.838
Elementi	19	€	2.173,79	2.605,09	2.883,82	3.138,80	3.500,18	4.314,71	4.591,54
Lungh. (mm)	874	Watt	4.864	5.757	6.346	6.935	7.828	8.721	9.329
Elementi	20	€	2.288,20	2.742,20	3.035,60	3.304,00	3.684,40	4.541,80	4.833,20
Lungh. (mm)	920	Watt	5.120	6.060	6.680	7.300	8.240	9.180	9.820
Elementi	21	€	2.402,61	2.879,31	3.187,38	3.469,20	3.868,62	4.768,89	5.074,86
Lungh. (mm)	966	Watt	5.376	6.363	7.014	7.665	8.652	9.639	10.311
Elementi	22	€	2.517,02	3.016,42	3.339,16	3.634,40	4.052,84	4.995,98	5.316,52
Lungh. (mm)	1012	Watt	5.632	6.666	7.348	8.030	9.064	10.098	10.802
Elementi	23	€	2.631,43	3.153,53	3.490,94	3.799,60	4.237,06	5.223,07	5.558,18
Lungh. (mm)	1058	Watt	5.888	6.969	7.682	8.395	9.476	10.557	11.293
Elementi	24	€	2.745,84	3.290,64	3.642,72	3.964,80	4.421,28	5.450,16	5.799,84
Lungh. (mm)	1104	Watt	6.144	7.272	8.016	8.760	9.888	11.016	11.784
Elementi	25	€	2.860,25	3.427,75	3.794,50	4.130,00	4.605,50	5.677,25	6.041,50
Lungh. (mm)	1150	Watt	6.400	7.575	8.350	9.125	10.300	11.475	12.275
Elementi	26	€	2.974,66	3.564,86	3.946,28	4.295,20	4.789,72	5.904,34	6.283,16
Lungh. (mm)	1196	Watt	6.656	7.878	8.684	9.490	10.712	11.934	12.766
Elementi	27	€	3.089,07	3.701,97	4.098,06	4.460,40	4.973,94	6.131,43	6.524,82
Lungh. (mm)	1242	Watt	6.912	8.181	9.018	9.855	11.124	12.393	13.257
Elementi	28	€	3.203,48	3.839,08	4.249,84	4.625,60	5.158,16	6.358,52	6.766,48
Lungh. (mm)	1288	Watt	7.168	8.484	9.352	10.220	11.536	12.852	13.748
Elementi	29	€	3.317,89	3.976,19	4.401,62	4.790,80	5.342,38	6.585,61	7.008,14
Lungh. (mm)	1334	Watt	7.424	8.787	9.686	10.585	11.948	13.311	14.239
Elementi	30	€	3.432,30	4.113,30	4.553,40	4.956,00	5.526,60	6.812,70	7.249,80
Lungh. (mm)	1380	Watt	7.680	9.090	10.020	10.950	12.360	13.770	14.730

Zehnder Charleston

Tipo di allacciamento	Codice	Suppl.€	Disegni e note
	<p>3370</p> <p>9906</p>	<p>135,04</p>	<p>$L_2 = \text{sporgenza filettatura, } 1/2'' = 6 \text{ mm;}$ $3/4'' = 15 \text{ mm}$ (minimo 4 elementi)</p>
	<p>3470</p>	<p>135,04</p>	<p>$L_2 = \text{sporgenza filettatura} = 6 \text{ mm (possibile solo } 1/2'')$</p> <p>Disposizione centrale dei raccordi solo in caso di numero pari di elementi (minimo 4 elementi)</p>
Allacciamento monotubo			
	<p>2070</p>	<p>-</p>	<p>$a = 2 \text{ colonne } 29 \text{ mm}$ $3-6 \text{ colonne } 33 \text{ mm}$</p>
	<p>3070</p> <p>5010</p>	<p>67,64</p> <p>67,64</p>	<p>$L_2 = \text{sporgenza filettatura, } 1/2'' = 6 \text{ mm;}$</p>

In fase d'ordine specificare obbligatoriamente il tipo di allacciamento desiderato. In base alla tipologia di allacciamento e alle dimensioni del radiatore, la produzione si riserva la possibilità di prevedere un "foro" tecnico supplementare, il tappo non viene fornito.

- H = altezza
- L = lunghezza
- N = interasse
- Quote in mm
- * = sfiato
- Δ = scarico
- = diaframma

Diametro standard allacciamenti, sfiato e scarico: 1/2''
 Ordini possibili a partire da 2 elementi, altre limitazioni indicate nella tipologia di allacciamento

Classe di sconto: F0

Zehnder Charleston

Tipo di allacciamento **Codice Suppl.€** Disegni e note

Allacciamento Completo con valvola integrata (prezzi senza testa termostatica)

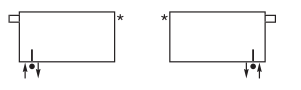
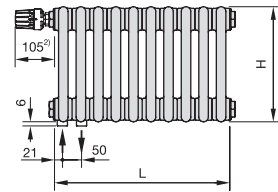
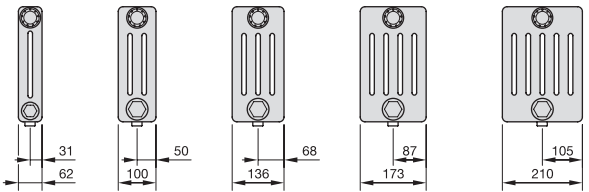
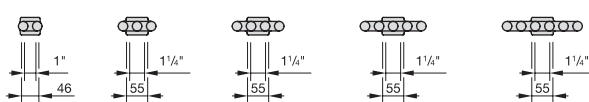
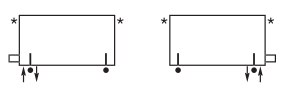
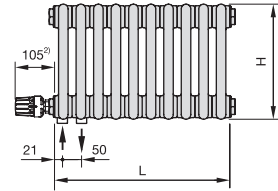
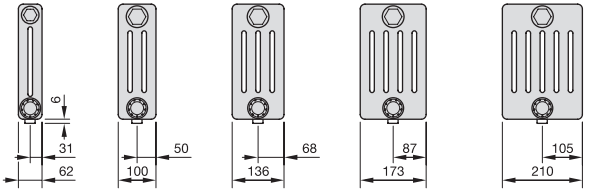
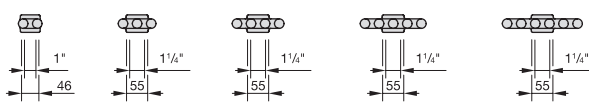
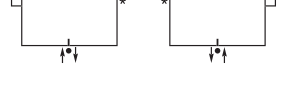
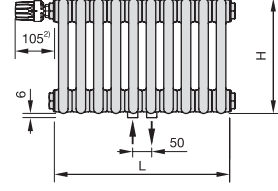
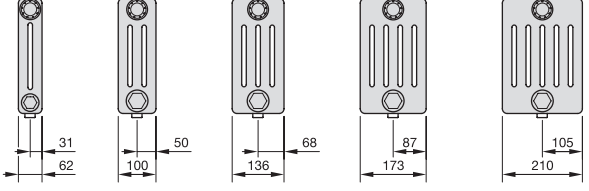
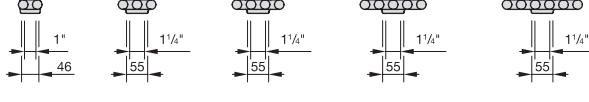
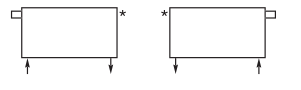
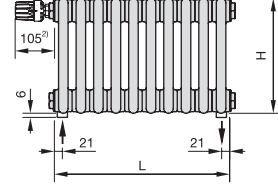
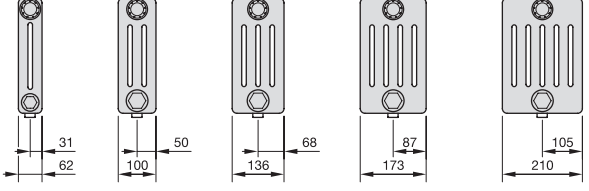
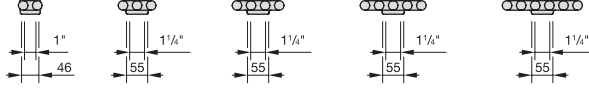
	<p>V001</p>	<p>170,47</p>	  <p>2) = quota valida solo per la testina termostatica Zehnder LH2</p>  <p>(minimo 4 elementi)</p>
	<p>V003</p>	<p>170,47</p>	  <p>2) = quota valida solo per la testina termostatica Zehnder LH2</p>  <p>Riduzione della potenza termica del primo elemento a causa del ricircolo insufficiente (minimo 4 el.)</p>
	<p>V007</p>	<p>340,94</p>	  <p>2) = quota valida solo per la testina termostatica Zehnder LH2</p>  <p>Allacciamento centrale possibile solo in caso di numero pari di elementi (minimo 6 elementi).</p>
<p>Valvola in alto allacciamento bilaterale</p> 	<p>V011</p>	<p>170,47</p>	  <p>2) = quota valida solo per la testina termostatica Zehnder LH2</p>  <p>(minimo 4 elementi)</p>

In fase d'ordine specificare obbligatoriamente il tipo di allacciamento desiderato. In base alla tipologia di allacciamento e alle dimensioni del radiatore, la produzione si riserva la possibilità di prevedere un "foro" tecnico supplementare, il tappo non viene fornito.

Dati caratteristici della valvola:

in fabbrica viene montata la valvola di regolazione speciale OV9 1" (per radiatori a 2 colonne) oppure OV9 5/4" (per radiatori da 3 a 6 colonne). Portata max. consigliata 250 kg/h.

H = altezza
L = lunghezza
N = interasse

* = sfiato
Δ = scarico
• = diaframma

Diametro standard allacciamenti, sfiato e scarico: 1/2"

Ordini possibili a partire da 2 elementi, altre limitazioni indicate nella tipologia di allacciamento.

Quote in mm

Classe di sconto: F0

Zehnder Charleston

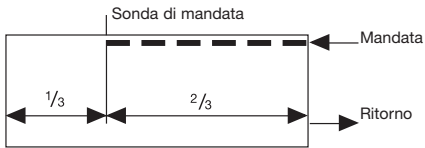
Versione differenti dallo standard	Prezzo €
<p>Sonda di mandata</p> <p>Nei radiatori Zehnder Charleston con allacciamento 1270/7610, a partire dai numeri di elementi o dalle lunghezze seguenti, può essere montata in fabbrica una sonda di mandata a 2/3 della lunghezza del radiatore, in modo da garantire le potenze termiche indicate nel catalogo:</p> <p>2 colonne a partire da 87 elementi = lunghezza 4002 mm 3 colonne a partire da 85 elementi = lunghezza 3910 mm 4 colonne a partire da 81 elementi = lunghezza 3726 mm 5 colonne a partire da 71 elementi = lunghezza 3266 mm 6 colonne a partire da 55 elementi = lunghezza 2530 mm</p> 	78,53

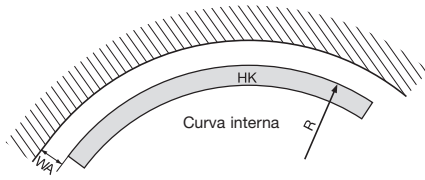
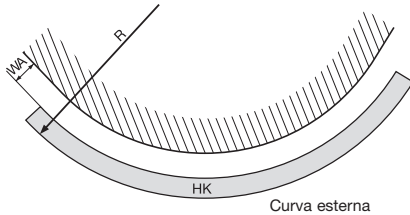
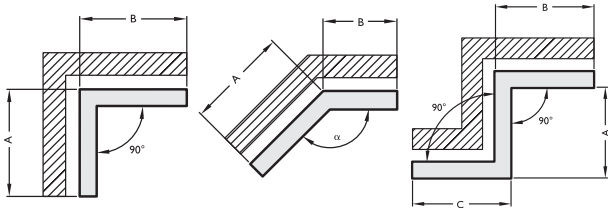
Versione curva e angolata	Prezzo €	
<p>Versione</p> <p>I radiatori Zehnder Charleston sono disponibili con i seguenti raggi di curvatura esterni minimi:</p> <p>2 colonne: 400 mm (400 mm) 3 colonne: 650 mm (1000 mm) 4 colonne: 750 mm (1250 mm) 5 colonne: 900 mm (1750 mm) 6 colonne: 1000 mm (2000 mm)</p> <p>I valori entro le parentesi si riferiscono ai limiti in caso di utilizzo di mensole con supporti BH.</p> <p>Nello Zehnder Charleston - versione Completo i primi tre elementi non vengono curvati.</p>	 <p style="text-align: center;">Disegno / Dima</p> 	Supplemento: +20,18 € per elemento
<p>Esecuzioni speciali ad angolo</p> <p>Esecuzioni speciali ad angolo fornite da 90° a 180°. All'ordine, si prega di allegare disegno con misure ed indicare:</p> <p>1) misure A, B, C in mm; 2) angolo α in gradi.</p> <p>Per esecuzioni ad angolo di 90° verrà proposta la tipologia di "angolo" più idonea, su richiesta è possibile ricevere le varie tipologie disponibili.</p>	<p>Esempi</p> 	Su richiesta

HK = radiatore
WA = distanza dalla parete
R = raggio
 α = angolo [°]

Quote in mm

Classe di sconto: F0

Zehnder Charleston EasyAccess



La soluzione Zehnder più semplice e comoda per la ristrutturazione.

Con la variante Charleston EasyAccess è possibile, infatti, sostituire un radiatore preesistente evitando interventi di trasformazione delle tubature, recuperando spazio in altezza e regalando un'alternativa estetica assolutamente confortevole.



Classe di sconto: F0

Zehnder Charleston EasyAccess

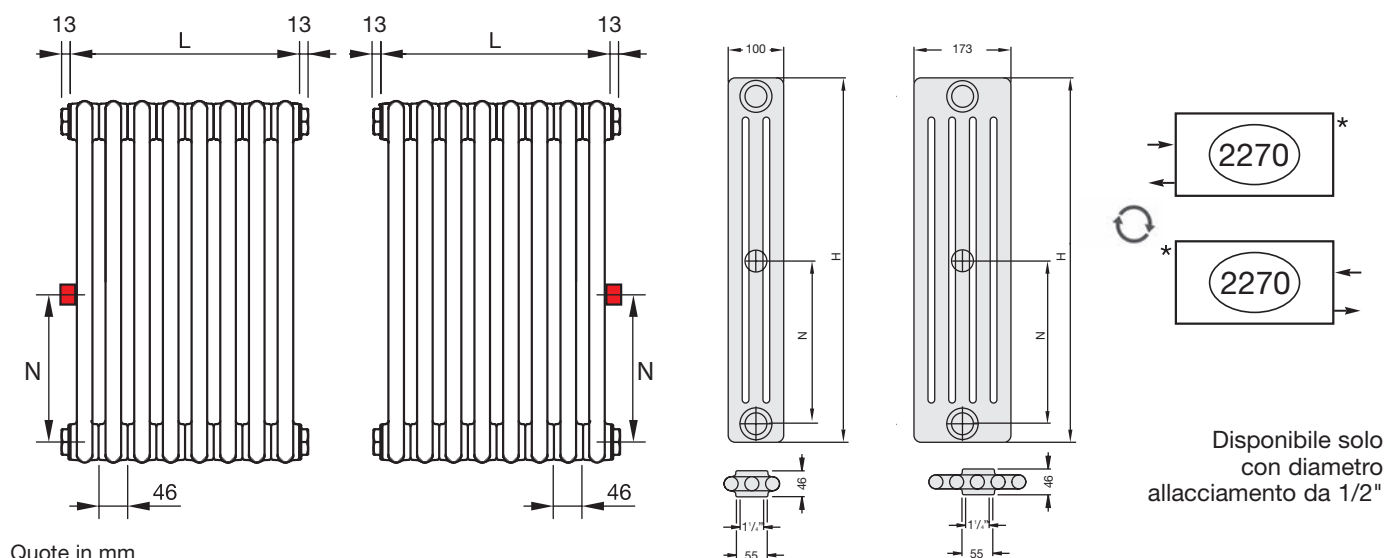

DATI TECNICI PER ELEMENTO

Modello	H	P	V	M	Esp.	$\Delta T 50$	$\Delta T 30$	Prezzo ad elemento	Suppl.to per EasyAccess (2270)
	mm	mm	dm ³	kg	n	Watt	Watt	€	€
3180	1800	100	2,4	3,58	1,32	166,0	84,6	70,73	+ 67,64
3200	2000	100	2,6	3,97	1,32	183,0	93,2	78,65	+ 67,64
5180	1800	173	3,9	6,08	1,32	259,0	132	112,11	+ 67,64
5200	2000	173	4,3	6,73	1,32	285,0	145,2	124,50	+ 67,64

Numero minimo di elementi: 4.

COMPOSIZIONE CODICE PER ORDINAZIONE RADIATORE SU MISURA

Modello	3	180	012	2270	9016
3180-012-2270-9016	Numero colonne	modello	Numero elementi	Allacciamento EasyAccess	Finitura

In fase d'ordine indicare la misura dell'interasse "N" tra quelli possibili (mm)

450 NEW	500	550 NEW	600	619	700	800	819	850 NEW	900
----------------	------------	----------------	------------	------------	------------	------------	------------	----------------	------------

LEGENDA

P: Profondità

H: Altezza

N: Interasse

V: Contenuto d'acqua

M: Peso a vuoto

Es: Esponente

 $\Delta T30$: Potenza termica (55/45/20) $\Delta T50$: Potenza termica EN 442 (75/65/20)

Prezzo versione standard RAL 9016







Classe di sconto: F0

Zehnder Charleston

Descrizione	Pezzi singoli				Confezioni					
	RAL 9016		Colore		5 pz.	10 pz.	RAL 9016		Colore	
	Articolo	Prezzo cad.	Articolo	Prezzo cad.			Articolo	Prezzo cad.	Articolo	Prezzo cad.
Tappo cieco per 2 colonne 1" destro	906021	5,39	906029	7,57		•	906041	54,22	906049	75,66
Tappo cieco per 2 colonne 1" sinistro	907021	5,39	907029	7,57		•	907041	54,22	907049	75,66
Tappo cieco per 3-6 colonne 5/4" destro	906031	5,39	906039	7,57	•		906071	27,16	906079	37,83
Tappo cieco per 3-6 colonne 5/4" sinistro	907031	5,39	907039	7,57	•		907071	27,16	907079	37,83
Riduzioni per allacciamenti per 2 colonne 1" x 1/4" destro	908221	5,39	908229	7,57		•	908241	54,22	908249	75,66
Riduzioni per allacciamenti per 2 colonne 1" x 1/4" sinistro	909221	5,39	909229	7,57		•	909241	54,22	909249	75,66
Riduzioni per allacciamenti per 2 colonne 1" x 3/8" destro	908321	5,39	908329	7,57		•	908341	54,22	908349	75,66
Riduzioni per allacciamenti per 2 colonne 1" x 3/8" sinistro	909321	5,39	909329	7,57		•	909341	54,22	909349	75,66
Riduzioni per allacciamenti per 2 colonne 1" x 1/2" destro	908421	5,39	908429	7,57		•	908441	54,22	908449	75,66
Riduzioni per allacciamenti per 2 colonne 1" x 1/2" sinistro	909421	5,39	909429	7,57		•	909441	54,22	909449	75,66
Riduzioni per allacciamenti per 2 colonne 1" x 3/4" destro	908521	5,39	908529	7,57		•	908541	54,22	908549	75,66
Riduzioni per allacciamenti per 2 colonne 1" x 3/4" sinistro	909521	5,39	909529	7,57		•	909541	54,22	909549	75,66
Riduzioni per allacciamenti per 3-6 colonne 5/4" x 1/4" destro	908231	5,39	908239	7,57	•		908271	27,16	908279	37,83
Riduzioni per allacciamenti per 3-6 colonne 5/4" x 1/4" sinistro	909231	5,39	909239	7,57	•		909271	27,16	909279	37,83
Riduzioni per allacciamenti per 3-6 colonne 5/4" x 3/8" destro	908331	5,39	908339	7,57	•		908371	27,16	908379	37,83
Riduzioni per allacciamenti per 3-6 colonne 5/4" x 3/8" sinistro	909331	5,39	909339	7,57	•		909371	27,16	909379	37,83
Riduzioni per allacciamenti per 3-6 colonne 5/4" x 1/2" destro	908431	5,39	908439	7,57	•		908471	27,16	908479	37,83
Riduzioni per allacciamenti per 3-6 colonne 5/4" x 1/2" sinistro	909431	5,39	909439	7,57	•		909471	27,16	909479	37,83
Riduzioni per allacciamenti per 3-6 colonne 5/4" x 3/4" destro	908531	5,39	908539	7,57	•		908571	27,16	908579	37,83
Riduzioni per allacciamenti per 3-6 colonne 5/4" x 3/4" sinistro	909531	5,39	909539	7,57	•		909571	27,16	909579	37,83
Riduzioni per allacciamenti per 3-6 colonne 5/4" x 1" destro	908631	5,39	908639	7,57	•		908651	27,16	908659	37,83
Riduzioni per allacciamenti per 3-6 colonne 5/4" x 1" sinistro	909631	5,39	909639	7,57	•		909651	27,16	909659	37,83

Classe di sconto: F0

Zehnder Charleston

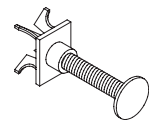
Descrizione		RAL 9016		Colore	
		Articolo	Prezzo €	Articolo	Prezzo cad.
	Guarnizioni per tappi per 2 colonne 1"	915041	1,95	-	-
	Guarnizioni per tappi per 3-6 colonne 5/4"	915051	1,95	-	-
	Guarnizioni per nippel per 2 colonne 1"	915021	1,95	-	-
	Guarnizioni per nippel per 3-6 colonne 5/4"	915031	1,95	-	-
	Nippel per 2 colonne 1"	911020	2,87	-	-
	Nippel per 3-6 colonne 5/4"	911030	2,87	-	-
	Kit-2 colonne: 4 riduzioni per allacciamenti da 1/2" /sfiato/tappo cieco	908481	29,81	-	-
	Kit-3-6 colonne: 4 riduzioni per allacciamenti da 1/2" /sfiato/tappo cieco	908491	29,81	-	-
	Diaframmi per 2 colonne 1"	911110	7,79	-	-
	Diaframmi per 3-6 colonne 5/4"	911120	9,17	-	-
	Chiave per tappi in materiale plastico	901030	10,43	-	-
	 Distanziale DS in plastica, distanza dalla parete 15-60 mm	780000	5,04	-	-

Descrizione		RAL 9016		Colore	
		Articolo	Prezzo €	Articolo	Prezzo
	Coppia di mensole FI con fissaggio a tassello (NON DISPONIBILE per finitura Technoline)				
	FI per 2 colonne L=178 mm: Ls=41-70 mm; WA=10-39 mm	801501	6,43	801509	16,85
	FI per 3 colonne L=198 mm: Ls=52-81 mm; WA=10-31 mm	801511	6,53	801519	17,08
	FI per 4 colonne L=218 mm: Ls=78-105 mm; WA=10-37 mm	801521	8,37	801529	17,43
	FI per 5 colonne L=258 mm: Ls=102-130 mm; WA=15-43 mm	801531	8,48	801539	19,60
	FI per 6 colonne L=258 mm: Ls=120-130 mm; WA=15-25 mm	801531	8,48	801539	19,60

Classe di sconto: F0

Zehnder Charleston

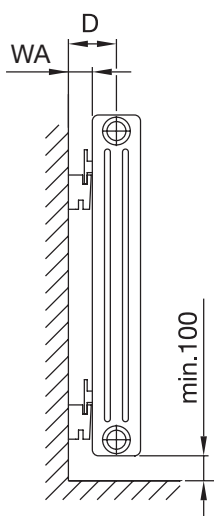

	CVD0	CVD1	CVD2
WA	23/28	38/43	58/63
D (mm)			
	54/59	69/74	89/94
	73/78	88/93	108/113
	91/96	106/111	126/131
	109/114	124/129	144/149
	128/133	143/148	163/168

E' possibile richiedere le mensole, nella quantità minima consigliata in tabella, nella stessa finitura (coppia di molle di sicurezza comprese) direttamente nell'imballo del radiatore Zehnder Charleston. **Solo per BH+CVD0 e BH+CVD1**

In caso di numero di elementi dispari, l'asse centrale è spostato di 23 mm.

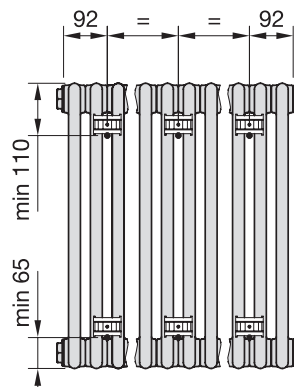

Descrizione	RAL 9016		Colore		Classe di sconto
	Articolo	Prezzo cad. €	Articolo	Prezzo cad. €	
Supporto BH (per Zehnder Charleston) Consigliato con l'utilizzo delle mensole CVDx	774001	3,90	774009	5,50	F0
Mensola CVD0 con elemento fonoisolante	795031	4,13	795039	5,96	F6
Mensola CVD1 con elemento fonoisolante	795041	4,13	795049	5,96	F6
Mensola CVD2 con elemento fonoisolante	795051	4,13	795059	5,96	F6
Coppia molla di sicurezza antiganciamento per mensole CVDx con supporto BH (consigliate solo sui punti di fissaggio superiori)	948012	1,38	-	-	F0

Numero punti di fissaggio con BH e CVDx per Zehnder Charleston

Elementi	Altezza prodotto			
	260 -1000 mm		1100 -1500 mm	
	da 2 a 6 colonne		da 2 a 5 colonne	
da 04 a 10	4	4	4	4
da 11 a 20	4	4	6	8
da 21 a 30	6	8	8	10
da 31 a 40	6	8	10	14
da 41 a 60	8	10	-	-

Classe di sconto: F0

Zehnder Charleston

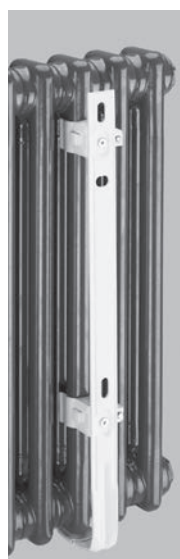

SMB30-75

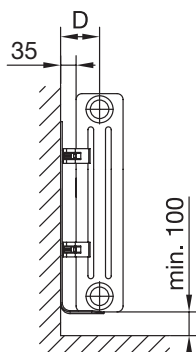

SMB2T

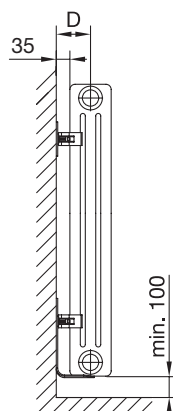

E' possibile richiedere le mensole, nella quantità minima consigliata in tabella, nella stessa finitura e direttamente nell'imballo del radiatore Zehnder Charleston. **SMB o SMB2 in base all'altezza.**

Descrizione	RAL 9016		Colore		Classe di sconto
	Articolo	Prezzo cad. €	Articolo	Prezzo cad. €	
SMB30 Coppia di supporti SMB30 - per modelli con altezza da 300 a 369 mm, con elemento fonoisolante (carico massimo per ogni asse: 100 kg)	173521	47,11	173529	66,03	F0
SMB40 Coppia di supporti SMB40 - per modelli con altezza da 370 a 484 mm, con elemento fonoisolante (carico massimo per ogni asse: 100 kg)	173531	47,11	173539	66,03	F0
SMB50 Coppia di supporti SMB50 - per modelli con altezza da 485 a 679 mm, con elemento fonoisolante (carico massimo per ogni asse: 100 kg)	173541	47,11	173549	66,03	F0
SMB75 Coppia di supporti SMB75 - per modelli con altezza da 680 a 1000 mm, con elemento fonoisolante (carico massimo per ogni asse: 100 kg)	173551	47,11	173559	66,03	F0
SMB2T Coppia di supporti SMB2T - per modelli con altezza da 1001 a 2200 mm, con elemento fonoisolante (carico massimo per ogni asse: 100 kg)	173511	47,11	173519	66,03	F0
 Coppia supporti a morsetto da utilizzarsi a integrazione per mensole EasyFix o per garantire la verticalità dei prodotti abbinati ai piedini	173401	26,26	173409	36,69	F0

Numero punti di fissaggio con supporti SMB30-75 e SMB2T - per Zehnder Charleston

Altezza prodotto

Elementi	300 -1000 mm		1001 -1500 mm		1501 -2200 mm	
	da 2 a 4 colonne	da 5 a 6 colonne	da 2 a 4 colonne	da 5 a 6 colonne	da 2 a 4 colonne	da 5 a 6 colonne
da 04 a 10	2	2	2	2	2	2
da 11 a 15	2	2	2	3	3	3
da 16 a 20	2	3	3	3	3	4
da 21 a 27	3	3	3	4	4	5
da 28 a 29	3	3	3	4	4	-
da 30 a 39	3	4	4	5	5	-
da 40 a 41	4	4	4	5	5	-
da 42 a 45	4	5	4	-	-	-
da 46 a 50	4	5	5	-	-	-
da 51 a 55	5	5	5	-	-	-
da 55 a 60	5	-	5	-	-	-

Classe di sconto: F0

Zehnder Charleston

Descrizione	RAL 9016		Colore			
	Articolo	Prezzo €	Articolo	Prezzo €		
 <p>Piedino saldato con altezza fissa (copripiedino non incluso), altezza massima consigliata del radiatore senza supporti a parete: 600 mm</p> <p>Il numero di piedini per batteria è determinato in modo automatico in base al numero di elementi (in caso di elementi e piedini dispari il piedino mediano non sarà centrato):</p> <p>da 6 a 20 elementi: 2 piedini da 21 a 40 elementi: 3 piedini da 41 a 60 elementi: 4 piedini da 61 a 80 elementi: 5 piedini</p>	WF150: Altezza piedino standard: 150 mm		55,14 cad.			
	WFFCUS: Altezza piedino su misura (possibile da 80 mm a 350 mm)		66,83 cad.			
 <p>Copripiedino circolare per piedini fissi</p>	753041	9,86 cad.	753049	13,76 cad.		
 <p>Coppia piedini tradizionali saldati con altezza fissa, altezza massima consigliata del radiatore senza supporti a parete: 600 mm</p> <p>Il numero di piedini per batteria è determinato in modo automatico in base al numero di elementi (in caso di elementi e piedini dispari il piedino mediano non sarà centrato):</p> <p>da 4 a 20 elementi: 2 coppie di piedini da 21 a 40 elementi: 3 coppie di piedini da 41 a 60 elementi: 4 coppie di piedini da 61 a 80 elementi: 5 coppie di piedini</p>	WF100: Altezza piedini standard: 100 mm		56,41 a coppia			
	WFTF150: Altezza piedini: 150 mm		59,04 a coppia			
 <p>Piedino saldato regolabile (copripiedino incluso), altezza massima consigliata del radiatore senza supporti a parete: 600 mm</p> <p>Il numero di piedini per batteria è determinato in modo automatico in base al numero di elementi (in caso di elementi e piedini dispari il piedino mediano non sarà centrato):</p> <p>da 6 a 20 elementi: 2 piedini da 21 a 40 elementi: 3 piedini da 41 a 60 elementi: 4 piedini da 61 a 80 elementi: 5 piedini</p>	WF120: Altezza standard: da 120 a 170 mm		56,41 cad.			
	WF170: Altezza piedino: da 170 a 350 mm		73,37 cad.			
 <p>Piedino regolabile HFK da avvitare (senza copripiedino)</p>	Altezza regolabile da 140 a 170 mm		754411	68,22 cad.	754419	95,50
	Altezza regolabile da 170 a 350 mm		754421	74,75 cad.	754429	104,66 cad.
 <p>Copripiedino in materiale plastico per piedini regolabili e HFK</p>	753031	6,76 cad.	753039	9,63 cad.		

Classe di sconto: F0

Zehnder Charleston - accessori

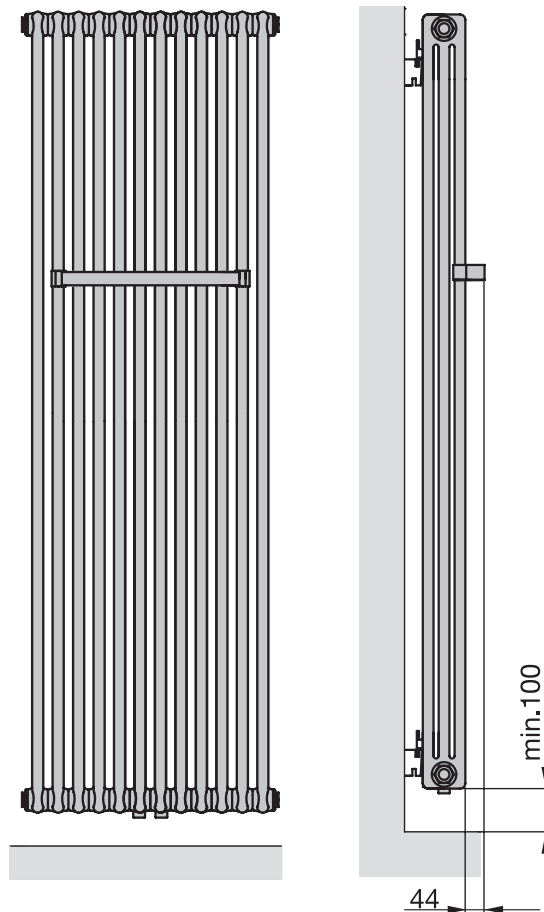

	Descrizione	Articolo	Prezzo €
	<p>Barra portasalviette cromata; possibilità di ridurre la lunghezza della barra per il montaggio su Zehnder Charleston con numero di elementi inferiore.</p> <p>Lunghezza totale: 366 mm (fino a 9 elementi) Lunghezza totale: 918 mm (fino a 20 elementi)</p>	<p>966018 966028</p>	<p>170,47 183,66</p>
	<p>Spazzola in lana naturale per la pulizia facilitata tra gli elementi di Zehnder Charleston</p>	<p>601020</p>	<p>45,85</p>



www.zehnder.it



[zehnder_italy](#)



[zehnder group italia](#)



[zehnder group italia](#)

Zehnder Group Italia Srl

Via XXV Luglio 6 · 41011 Campogalliano (MO) · Italia
T +39 059 978 62 00 · F +39 059 978 62 01
info@zehnder.it · www.zehnder.it

zehnder

Z_IT_V0123_RAD_PRL_it, documento non contrattuale, con riserva di modifiche