

Termostato programmabile T3, T3R, T3M

IT Guida utente

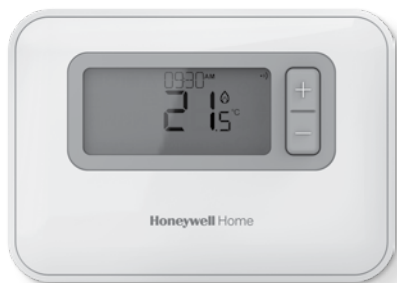

T3

Termostato programmabile

T3M

Termostato regolazione
programmabile



T3R

Termostato programmabile wireless

Indice

1) Interfaccia termostato	3
Panoramica sullo schermo e sui pulsanti.....	3
Icane di stato	4
Menu e icone di navigazione.....	4
Navigazione all'interno del menu.....	4
2) Menu	5
Programma riscaldamento.....	5
Regolazione del programma.....	5
Copia programma.....	7
Elimina periodo.....	7
Impostazioni (data e ora).....	8
3) Modalità dispositivo.....	11
Funzionamento automatico (AUTO)	11
Override temporaneo.....	11
Override di un'ora.....	11
Funzionamento manuale (MAN).....	12
Override permanente.....	12
Modalità standby (con protezione antigelo).....	13
4) Blocco tastierino	14
5) Ottimizzazione	15
6) Sostituzione delle batterie (solo T3 e T3R)	16
7) Supporto da tavolo e montaggio a parete (solo T3R)	17
8) Scatola del ricevitore wireless (solo T3R).....	19
9) Risoluzione dei problemi	20

1 Interfaccia termostato

Panoramica sullo schermo e sui pulsanti

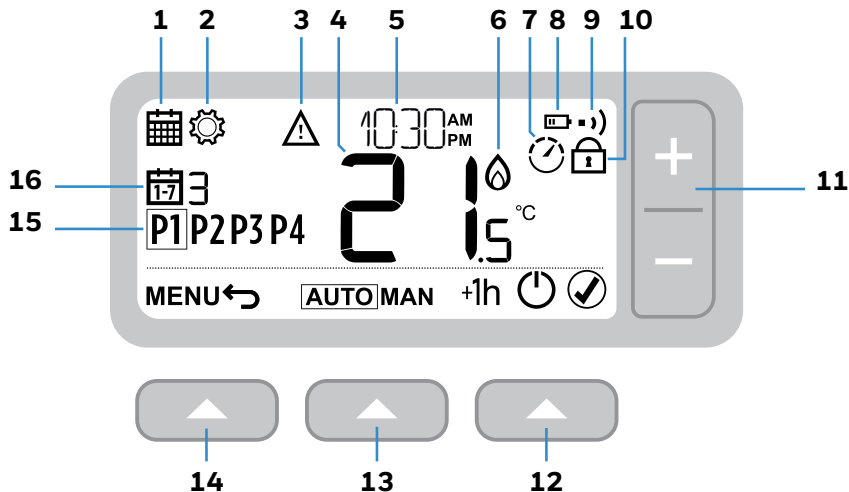





- 1** Menu di pianificazione
- 2** Menu Impostazioni
- 3** Allarme
- 4** Temperatura ambiente
- 5** Ora attuale
- 6** Richiesta calore
- 7** Ottimizzazione





- 8** Batteria scarica
- 9** Segnale wireless (solo T3R)
- 10** Blocco tastiera
- 11** Regolazione della temperatura
- 12** Pulsante destro

- 13** Pulsante centrale
- 14** Pulsante sinistro
- 15** Periodo di pianificazione
- 16** Giorno







Icone di stato

-  **Override temperatura attivo:** Visualizzato se la temperatura programmata è stata modificata manualmente.
-  **Batteria scarica:** Resta circa il 10% di carica (vedi Sostituzione delle batterie a pagina 16).
-  **Richiesta calore:** La temperatura ambiente è al di sotto del valore prefissato a indicare una richiesta di calore (la caldaia dovrebbe entrare in funzione).
-  **Ottimizzazione attiva:** Visualizzato solo se l'ottimizzazione è stata abilitata nelle impostazioni dell'installatore.
- +1h **Override di un'ora attivo:** L'override temporaneo è stato impostato per un'ora.
-) **Segnale wireless:** Il termostato (solo T3R) è collegato alla scatola del ricevitore.

Menu e icone di navigazione

- MENU** Opzioni e impostazioni del termostato
-  Impostazioni
 -  programma riscaldamento (data e ora)
-  **Indietro:** Torna alla schermata/ al menu precedente.
-  **Conferma:** Conferma una modifica o una selezione.
-  **Standby:** Avvia o arresta il riscaldamento.

Navigazione all'interno del menu

- Premere **MENU**  per accedere al menu principale.
- Premere + o – per selezionare una voce del menu; la voce selezionata inizia a lampeggiare.
- Premere   per confermare la selezione.
- Premere + o – per regolare un'impostazione e   per salvare la modifica o passare alla selezione successiva o premere   per tornare alla selezione precedente.

2 Menu

📅 Programma riscaldamento



Il termostato viene fornito con la seguente pianificazione predefinita.
Seguire i prossimi passaggi per regolare la pianificazione.

		P1	P2	P3	P4
Giorni da 1 a 7 (da lun a dom)	🕒	6:30	8:00	18:00	22:30
	🌡️	21 °C	16 °C	21 °C	16 °C

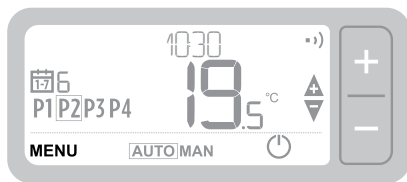

Regolazione del programma

1 Premere **MENU**  per accedere al menu principale.



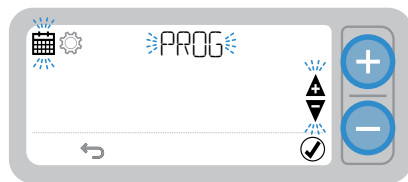

2 Premere **+ o -** per selezionare il menu pianificazione  e premere  .



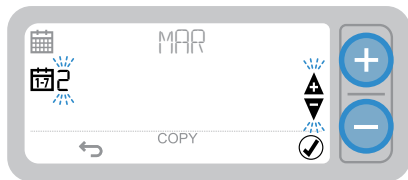

- 3 Premere + o – per selezionare il giorno da regolare e premere  



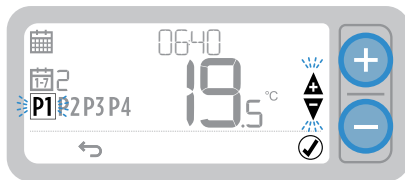

- 4 Premere + o – per selezionare il periodo da regolare e premere  



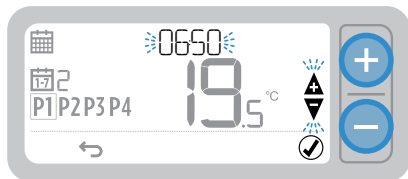

- 5 Premere + o – per regolare l'orario e premere  

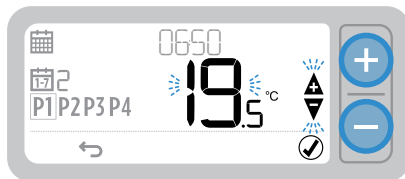

- 6 Premere + o – per regolare la temperatura e premere  



- 7 Ripetere questi passaggi per apportare modifiche ai periodi e ai giorni restanti o premere   per salvare le modifiche e tornare alla schermata iniziale.

Copia programma

- 1 Premere + o – per scegliere il giorno da cui si desidera **copiare** il programma e premere **COPIA**

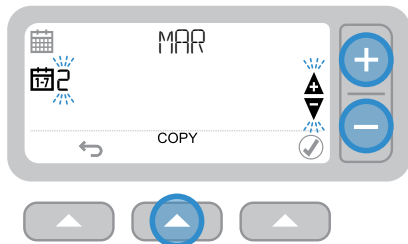

- 2 Premere + o – per scegliere il giorno su cui si desidera copiare **il programma** e premere

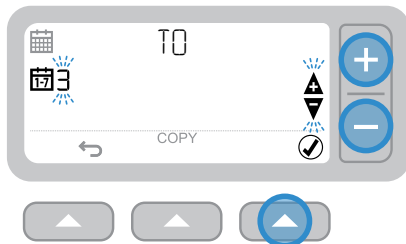

Elimina periodo

- 1 Andare al giorno e scegliere il periodo da eliminare.
- 2 Tenere premuto per 3 secondi e quindi premere .

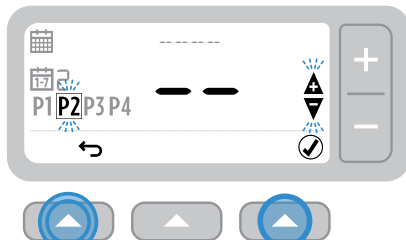
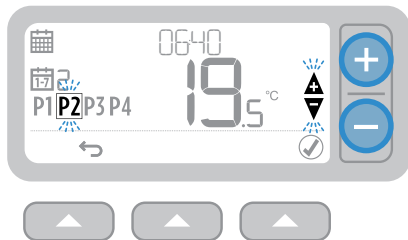





3 secondi

- 3 Ripetere i passi 1 e 2 per abilitare il periodo di nuovo.

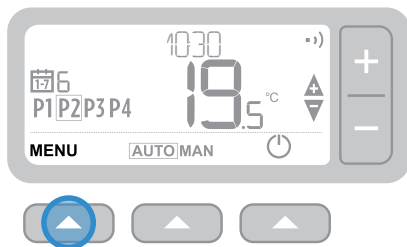
Impostazioni (data e ora)

- 1 Premere **MENU**  per accedere al menu principale.



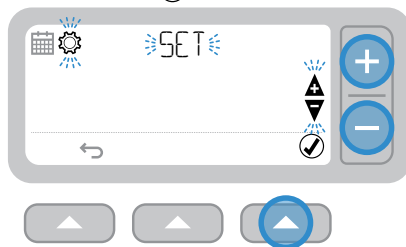

- 2 Premere + o - per selezionare le impostazioni del menu  SET, quindi premere  .

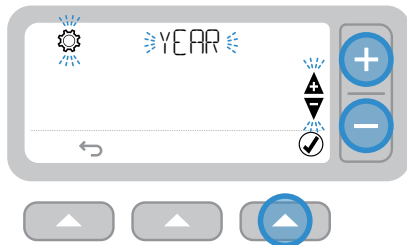

- 3 Premere   per selezionare ANNO (o + per passare a MESE)



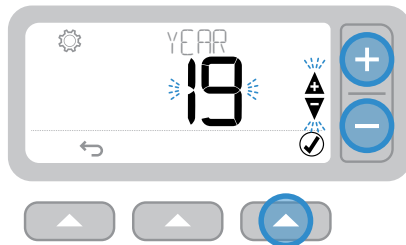

- 4 Premere + o - per regolare ANNO e premere  .

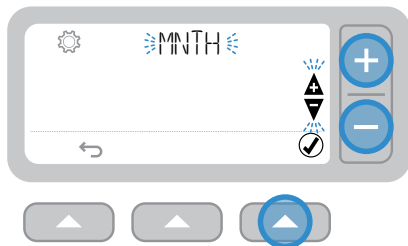

- 5 Premere   per selezionare MESE (o + per passare a GIORNO)



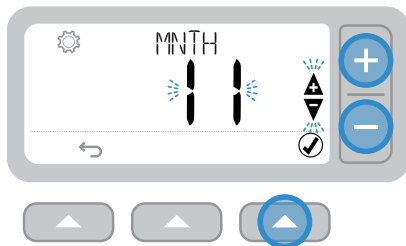

- 6 Premere + o - per regolare MESE e premere  

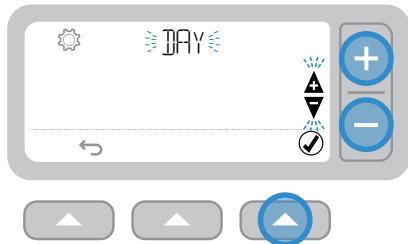

- 7 Premere   per selezionare GIORNO (o + per passare a ORA)



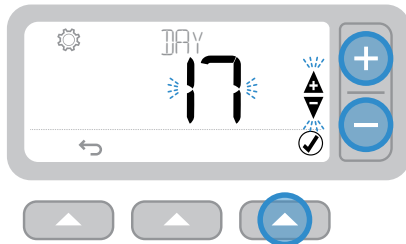

- 8 Premere + o - per regolare GIORNO e premere  

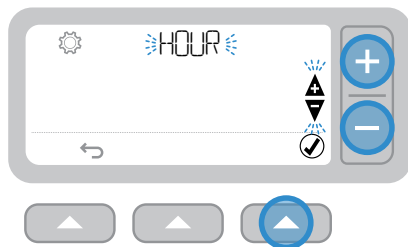

- 9** Premere   per selezionare ORA (o + per passare a ORA)



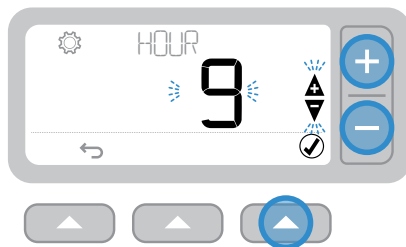

- 10** Premere + o - per regolare ORA e premere  

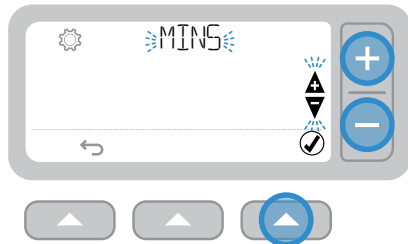

- 11** Premere   per selezionare MINUTO e premere  



- 12** Premere + o - per regolare MINUTO e premere  

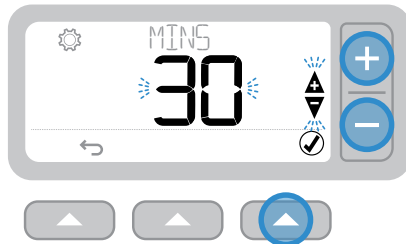

- 13** Premere   per uscire dalle IMPOSTAZIONI e tornare nella schermata iniziale

3 Modalità dispositivo

AUTO Funzionamento automatico

Durante il normale uso, il termostato seguirà la pianificazione impostata indicata dall'icona **AUTO**.

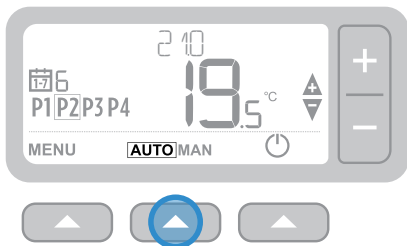

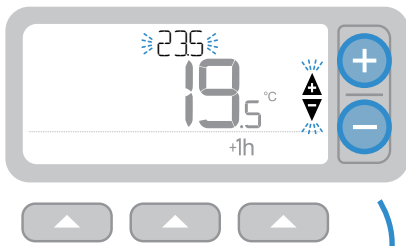

Override temporaneo

Premere il + o - per selezionare la nuova temperatura desiderata. Il cronoprogramma verrà ripristinato al raggiungimento del primo punto di intervento dello stesso.



Override di un'ora

Premere +1h  per un override di un'ora.
Premere +1h  di nuovo per annullare.

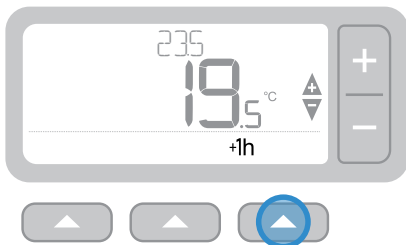

MAN Funzionamento manuale

La temperatura impostata è seguita in maniera permanente indicata dall'icona **MAN**.

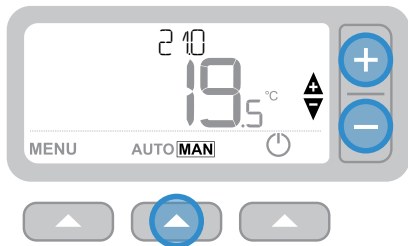

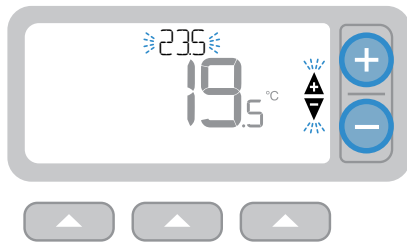

Override permanente

Premere i pulsanti + o - per regolare la temperatura. Questa temperatura è impostata fino a quando manualmente modificata nuovamente.



Modalità standby (con protezione antigelo)

Per risparmiare energia, disattivare il riscaldamento se non necessario, ad es. durante i mesi estivi o quando porte e finestre restano aperte a lungo. Se la temperatura scende a 5 °C, il riscaldamento si accenderà per evitare che i tubi si gelino.

- 1 Premere  per arrestare il riscaldamento. Sul display apparirà OFF
- 2 Premere  nuovamente per accendere il riscaldamento. Sul display apparirà **AUTO** o **MAN**

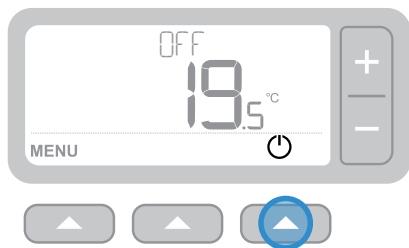

4 Blocco tastierino

Blocca

Tenere premuti i pulsanti sinistro e destro per 5 secondi. Il display visualizzerà l'icona  (a seconda dell'impostazione dall'installatore) e il termostato avrà funzionalità tastiera limitata o assente.

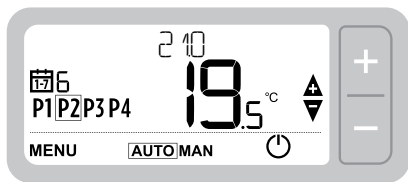

5 secondi

Sblocca

Quando la tastiera è bloccata (indicato dall'icona ) tenere premuti i pulsanti sinistro e destro per 5 secondi per ripristinare la funzionalità tastiera completa del termostato.

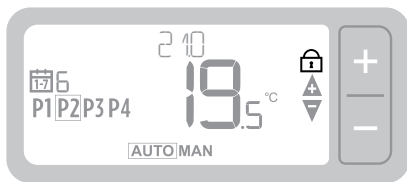

5 secondi

5 Ottimizzazione





Ottimizzazione

Il termostato è dotato di funzioni di ottimizzazione che aiutano a risparmiare energia mantenendo livelli ideali di confort. Il termostato visualizza  durante il periodo di ottimizzazione, se impostato. Per impostazione predefinita l'ottimizzazione è disabilitata, vedere le istruzioni nella guida all'installazione per l'attivazione.

- **Avvio ottimale** memorizza il tempo necessario per raggiungere la temperatura impostata all'interno della casa e quindi se è necessario accendere il riscaldamento un po' prima per raggiungere tale temperatura nell'orario programmato.
- **Avvio ritardato** risparmia energia ritardando leggermente l'avvio del riscaldamento in base alla differenza tra la temperatura impostata e la temperatura ambiente. Più queste temperature sono vicine maggiore sarà il ritardo.
- **Arresto ottimale** risparmia energia spegnendo il riscaldamento un po' prima rispetto all'orario programmato. Se la casa si trova alla giusta temperatura non noterete l'effetto sulla temperatura, ma dovrete notare la differenza in bolletta.

6 Sostituzione delle batterie (solo T3 e T3R)

Il termostato è alimentato mediante 2 batterie AA anche se non è visualizzata alcuna icona corrispondente sul display durante il normale uso. L'icona della batteria verrà visualizzata soltanto in caso di batteria bassa.

-  viene visualizzato quando la batteria ha raggiunto all'incirca il 10%; a questo punto è necessario sostituire le batterie quanto prima.
-  +  lampeggia quando il livello delle batterie è molto basso è necessario sostituirle **immediatamente** per fare in modo che non vi sia alcuna interruzione nel sistema di riscaldamento.
- Sostituire esclusivamente con 2 nuove batterie **da** alcaline **tipo AA LR6 da 1,5 V** la cui durata approssimativa è di 2 anni in base all'uso che si fa del termostato.

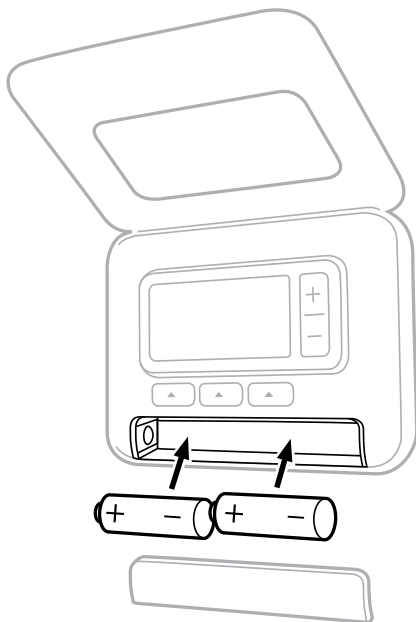

Invitiamo a contribuire alla salvaguardia dell'ambiente riciclando le vecchie batterie nel rispetto delle normative locali.

7 Supporto da tavolo e montaggio a parete
(solo T3R)

Supporto da tavolo

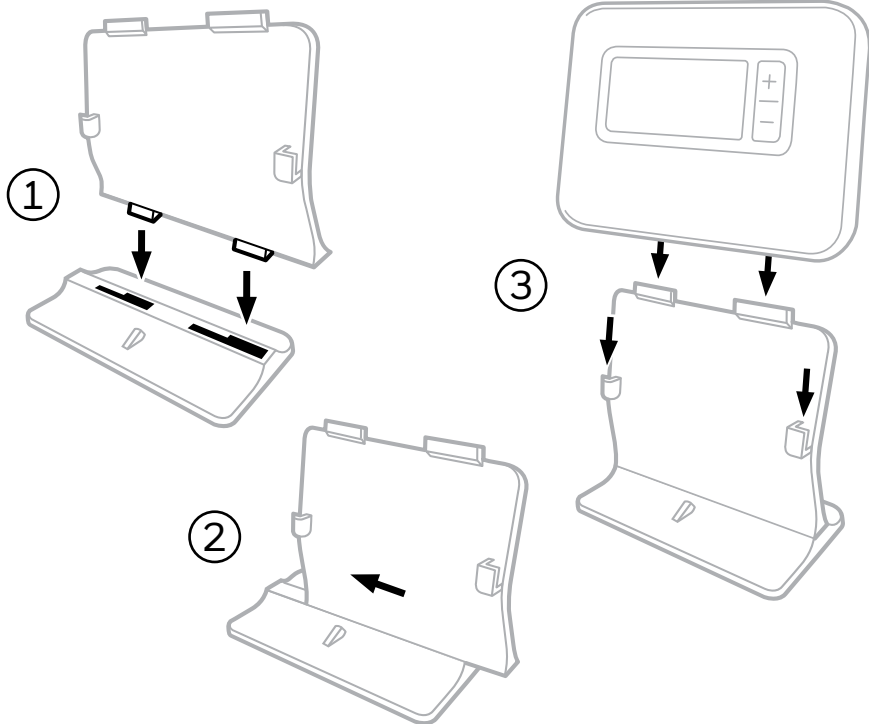

Montaggio a parete

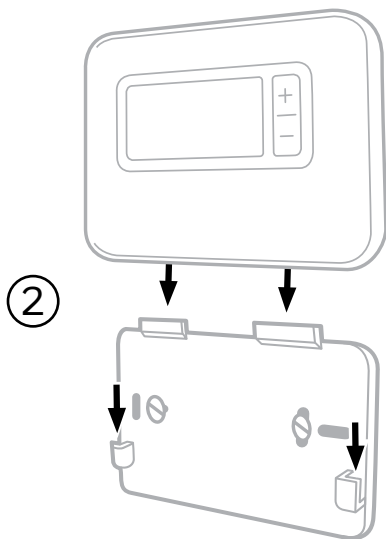
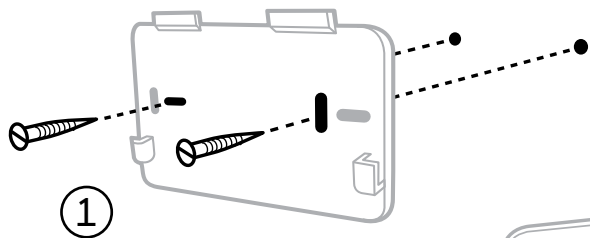

8 Scatola del ricevitore wireless (solo T3R)

Il termostato T3R comunica in modalità wireless con la scatola del ricevitore collegata alla caldaia. Se il termostato perde la comunicazione wireless o presenta dei guasti, la caldaia può essere accesa o spenta manualmente utilizzando il pulsante sulla scatola del ricevitore.

- **••)** viene visualizzato sul termostato in presenza di un buon segnale wireless. Il LED della scatola del ricevitore **••)** si illumina di VERDE in modo fisso.
- **Δ + ••)** lampeggia sul termostato in caso di perdita del segnale wireless. Il LED della scatola del ricevitore **••)** lampeggia in ROSSO.
- Se viene persa la comunicazione, spostare il termostato in un altro punto per riprovare e tentare di ripristinare la comunicazione.

Per eseguire l'override della caldaia utilizzando la scatola del ricevitore:

1. Premere il pulsante **una volta** per accendere o spegnere la caldaia. Il LED del pulsante deve essere:

- di colore VERDE quando la caldaia è accesa.
- spento quando la caldaia è spenta.

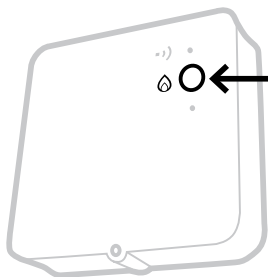







Premere il pulsante **una volta** per accendere o spegnere la caldaia (far trascorrere almeno 3 sec tra ogni pressione del pulsante).



Non premere il bottoncino di reset altrimenti i dati necessari al collegamento con il ricevitore verranno cancellati, causando problemi di funzionamento al sistema di riscaldamento.

9 Risoluzione dei problemi

Se si incontrano difficoltà con il termostato, provare con questi suggerimenti. La maggior parte dei problemi può essere risolta in modo veloce e semplice.

Tutti i modelli	
La schermata è vuota	Sostituire le batterie (solo T3 e T3R). Verificare che la caldaia OpenTherm sia alimentata (solo T3M). Contattare l'installatore.
Il termostato visualizza 	Le batterie hanno raggiunto il 10% di carica e devono essere sostituite quanto prima.
Il termostato visualizza 	Le batterie sono molto basse e devono essere sostituite immediatamente - vedere "Sostituzione delle batterie".
Il termostato visualizza  ma la caldaia non si accende.	La caldaia passa da accesa a spenta man mano che controlla la temperatura e alle volte l'icona  viene visualizzata quando la caldaia è spenta. Se la caldaia non si accende per un lungo periodo, contattare il proprio installatore.
Il sistema di riscaldamento non risponde alle regolazioni della temperatura.	Assicurarsi che la temperatura impostata sia più alta della temperatura ambiente. Controllare che il sistema di riscaldamento sia acceso. Controllare che la scatola del ricevitore sia accesa e che il termostato rilevi il segnale wireless (solo T3R).
Il termostato visualizza 	Il sensore della temperatura del termostato è difettoso, contattare il proprio installatore per riparare o sostituire il termostato.
 + SERV	La caldaia è dovuta essere serviti. Please contact your landlord or local housing authority.

Solo termostato T3R (wireless) e scatola del ricevitore

Il termostato lampeggia $\Delta + \bullet \cdot$) e il $\bullet \cdot$) LED della scatola del ricevitore lampeggia di ROSSO.	Segnale wireless perso. Spostare il termostato in un altro punto per riprovare e ripristinare la comunicazione.
Il termostato lampeggia $\Delta + \bullet \cdot$) e il $\bullet \cdot$) LED della scatola del ricevitore è spento.	Verificare che la scatola del ricevitore sia alimentata premendo il pulsante per accendere la caldaia. Se la scatola del ricevitore è alimentata, allora non è stato memorizzato alcun dato wireless vincolante.
Il LED della scatola del ricevitore $\bullet \cdot$) lampeggia di ARANCIONE.	La scatola del ricevitore è in modalità vincolante e ne uscirà dopo 3 minuti.

Solo termostato T3M (OpenTherm)

Una caldaia OpenTherm è in grado di inviare allarmi al termostato e ciò si rivela utile quando si contatta un installatore o un tecnico per la manutenzione. Questi allarmi possono essere visualizzati nel menu "Allarmi caldaia OpenTherm®".

Descrizione	ID	Codice errore	Letture OT
Richiesta di assistenza	001	01SR	0 = assistenza non richiesta 1 = assistenza richiesta
Pressione dell'acqua bassa	002	02WP	0 non = nessun guasto WP 1 = guasto WP
Guasto gas/fiamma	003	03GF	0 non = nessun guasto GF 1 = guasto GF
Guasto pressione aria	004	04AF	0 non = nessun guasto AP 1 = guasto AP
Surriscaldamento acqua	005	05WT	0 non = nessun guasto OVT 1 = guasto OVT
Specifico OEM	006	06OS	Codice specifico produttore caldaia

heatingcontrols.honeywellhome.com



resideo

Resideo Inc., Skimped Hill Lane, Bracknell,
Berkshire, RG12 1EB.

www.resideo.com

Paese d'origine: REGNO UNITO

©2018 Resideo Technologies, Inc. Tutti i diritti riservati. Il marchio Honeywell Home viene utilizzato licenza da Honeywell International Inc.



T3, T3R, T3M PROGRAMMABLE THERMOSTAT

- EN Quick Start User Guide**
NL Gebruikershandleiding
FR Mode d'emploi
DE Schnellstart-Anleitung
IT Guida utente
ES Guía de usuario

Online Guides

Online instructies / Instructions en ligne / Online Anleitung /
 Guide online / Instrucciones Online



http://hwll.co/T3_pdfs

1 Screen and button overview

Screen and button overview /
 Overzicht van schermen en knoppen /
 Aperçu de l'écran et des boutons /
 Bildschirm- und Schaltflächenübersicht /
 Panoramica sullo schermo e sui pulsanti /
 Resumen de pantalla y botones

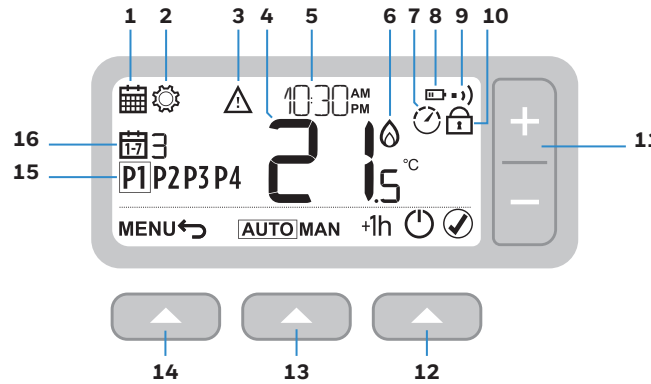

- 1 Programming Menu**
 Programmiermenu
 Menu de programmation
 Programmiermenü
 Menu di programmazione
 Menú de programación

- 2 Settings Menu**
 Instellingen Menu
 Menu Paramètres
 Einstellungs Menü
 Menu Impostazioni
 Menú de configuración

3 Alert

Alarm / Alerte / Alarm /
 Allarme / Alerta

4 Room Temperature

Kamertemperatuur /
 Température ambiante /
 Raumtemperatur /
 Temperatura ambiente /
 Temperatura ambiente

5 Current time

Huidige tijd / Heure actuelle /
 Aktuelle Uhrzeit / Ora attuale /
 Hora actual

6 Heat demand

Warmtevraag / Demande de chaleur /
 Wärmebedarf / Richiesta di calore /
 Demanda de calor

7 Optimisation

Optimalisatie / Optimisation /
 Optimisierung / Ottimizzazione /
 Optimización

8 Low battery

Lage batterij / Batterie faible /
 Niedriger Batteriestatus /
 Batteria scarica / Bateria baja

9 Wireless signal (T3R only)

Draadloos signaal (alleen T3R) /
 Signal sans fil (T3R uniquement) /
 Funk-Signal (nur T3R) /
 Segnale wireless (solo T3R) /
 Señal inalámbrica (solo T3R)

10 Keypad Lock

Toetsblokkering /
 Verrouillage du clavier /
 Tastensperre / Blocco tastiera /
 Bloqueo de teclado

11 Temperature adjust

Temperatuur aanpassen /
 Ajuster Température /
 Temperatur einstellen /
 Regolazione della temperatura /
 Ajuste de temperatura

12 Right button

Rechterknop / Bouton droit /
 Rechte Taste / Pulsante destro /
 Botón derecho

13 Middle button

Middelste knop / Bouton central /
 Mittlere Taste / Pulsante centrale /
 Botón central

14 Left button

Linkerknop / Bouton gauche /
 Linke Taste / Pulsante di sinistra /
 Botón izquierdo

15 Schedule period

Programma periode /
 Période de programmation /
 Zeitplan-Programmierung /
 Periodo di programmazione /
 Periodo de programación

16 Day

Dag / Jour / Tag / Giorno / Día

2 Default Schedule

Default Schedule

Standaard schema / Programmation par défaut /
 Standardzeitplan / Programma predefinito /
 Programa predeterminado

	P1	P2	P3	P4
	6:30	8:00	18:00	22:30
	21°C	16°C	21°C	16°C

Adjusting the Schedule

Het programma aanpassen / Modifier la programmation /
 Anpassen des Zeitplans / Regolazione del programma /
 Ajuste de la programación

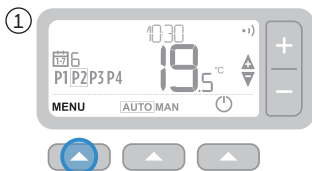

- Press MENU**
 Druk op MENU
 Appuyez sur MENU
 Drücken Sie auf MENU
 Premere MENU
 Presione MENÚ



- Select PROG then confirm**
 Selecteer PROG en bevestig
 Sélectionnez PROG puis confirmez
 Wählen Sie PROG und bestätigen Sie
 Seleziona PROG quindi conferma
 Seleccione PROG y confirme



- Select day then confirm**
 Selecteer een dag en bevestig
 Sélectionnez le jour puis confirmez
 Wählen Sie den Tag und bestätigen Sie
 Seleziona il giorno quindi conferma
 Seleccione el día y confirme



- Select period then confirm**
 Selecteer periode en bevestig
 Sélectionnez la période puis confirmez
 Wählen Sie den Zeitraum und bestätigen Sie
 Seleziona il periodo quindi conferma
 Seleccione un periodo y confirme

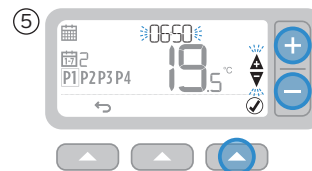

- Adjust time then confirm**
 Pas de tijd aan en bevestig
 Ajuster l'heure puis confirmer
 Passen Sie die Zeit an und bestätigen Sie
 Imposta l'orario quindi conferma
 Ajuste el horario y confirme

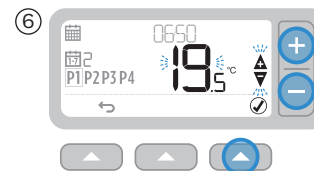

- Adjust temperature then confirm**
 Pas de temperatuur aan en bevestig
 Ajuster la température puis confirmer
 Temperatuur einstellen und bestätigen
 Regola la temperatura quindi conferma
 Ajuste la temperatura y confirme

Copy Day

Dag kopiëren / Copier un jour / Tag kopieren / Copia il giorno / Copiar día



- Select day then COPY**
 Selecteer een dag en dan COPY
 Sélectionnez le jour puis COPIE
 Wählen Sie den Tag und dann COPY
 Seleziona il giorno, quindi COPIA
 Seleccione el día y luego COPIAR

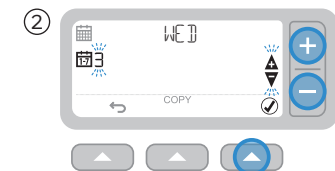

- Select "TO" day then confirm**
 Selecteer "TO" dag en bevestig vervolgens
 Sélectionnez "SUR" jour puis confirmez
 Wählen Sie "TO" Tag und bestätigen Sie dann
 Selezionare il giorno di destinazione, quindi confermare
 Seleccione el día al que copiar y luego confirme

Delete period

Wis periode / Supprimer la période / Zeitraum löschen / Elimina periodo / Eliminar período

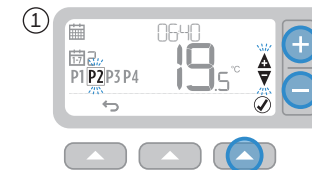

- Select period**
 Selecteer periode
 Sélectionnez une période
 Wählen Sie den Zeitraum aus
 Selezionare periodo
 Seleccionar periodo

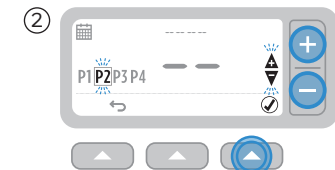

- Hold Left button for 3sec**
 Houd de linkerknop 3 seconden lang ingedrukt
 Maintenez le bouton gauche pendant 3sec
 Halten Sie die linke Taste 3 Sekunden lang gedrückt
 Tenere premuto il tasto sinistro per 3 secondi
 Mantenga presionado el botón izquierdo durante 3 segundos

3

Device Modes

Toestel Modus / Mode de fonctionnement / Betriebsarten des Geräts / Modalità dispositivo / Modos de funcionamiento

"AUTO"

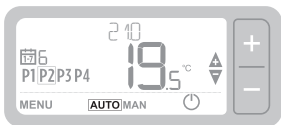

Programmed schedule is followed
Geprogrammeerd schema wordt gevolgd
L'horaire programmé est suivi
Programmierter Zeitplan wird umgesetzt
Il programma impostato verrà seguito
Se sigue el horario programado

"MAN"

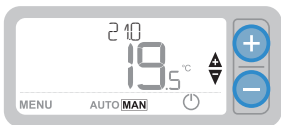

Only set temperature is followed
Alleen de ingestelde temperatuur wordt gevolgd
Seule la température réglée est suivie
Nur die eingestellte Temperatur wird umgesetzt
Viene seguida solo la temperatura impostata
Solo se sigue la temperatura seleccionada

"OFF"



Heating is OFF

Verwarming is UIT / Le chauffage est désactivé /
Heizung ist ausgeschaltet / Il riscaldamento è spento / La calefacción está apagada

4

Temperature Override

Temperatuur overschrijven / Dérogation / Temperaturüberschreibung /
Controllo manuale temporaneo / Anulación del programa

"AUTO"

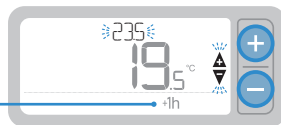

Temporary override until next programmed period
Tijdelijke aanpassing tot aanvang volgende periode
Dérogation temporaire jusqu'à la prochaine période programmée
Temporäre Übersteuerung bis zum nächsten programmierten Zeitraum
Override temporaneo fino al prossimo periodo programmato
Anulación temporal hasta el próximo periodo programado

"MAN"



Permanent override until manually changed
Permanente aanpassing tot handmatig gewijzigd
Dérogation permanente jusqu'à modification manuelle
Permanente Übersteuerung bis zur manuellen Änderung
Override permanente fino a quando verrà modificato manualmente
Anulación permanente hasta cambio manual programado

"+1h"



Press for one hour override

Druk om 1 uur te overbruggen
Appuyez pour une heure de priorité
Drücken Sie für eine Stunde
Temperaturüberschreibung
Premere per un override di un'ora
Presione para anular el programa durante una hora

5

Keypad Lock

Toetsblokkering / Verrouillage du clavier / Tastensperre /
Blocco tastiera / Bloqueo de teclado

Lock

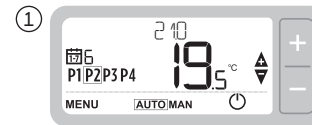

Hold Left & Right buttons for 5sec

Houd de knoppen Links en Rechts 5 seconden lang ingedrukt
Maintenez les boutons Gauche et Droite pendant 5 secondes
Halten Sie die Links- & Rechts-Tasten für 5 Sekunden gedrückt
Tenere premuti i pulsanti sinistro e destro per 5 secondi
Mantenga presionados los botones izquierdo y derecho durante 5 segundos

Unlock



Hold Left & Right buttons for 5sec

Houd de knoppen Links en Rechts 5 seconden lang ingedrukt
Maintenez les boutons Gauche et Droite pendant 5 secondes
Halten Sie die Links- & Rechts-Tasten für 5 Sekunden gedrückt
Tenere premuti i pulsanti sinistro e destro per 5 secondi
Mantenga presionados los botones izquierdo y derecho durante 5 segundos

6

Date and Time

Datum en tijd / Date et l'heure / Datum und Uhrzeit /
Data e ora / Fecha y hora



Press MENU

Druk op MENU
Appuyez sur MENU
Drücken Sie auf MENÜ
Selezionare MENU
Presione MENU

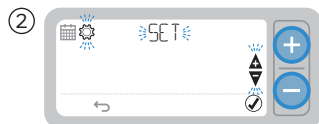

Select SETTINGS then confirm

Selecteer INSTELLINGEN en bevestig
Sélectionnez PARAMÈTRES puis confirmez
Wählen Sie EINSTELLUNGEN, danach bestätigen
Seleziona IMPOSTAZIONI quindi confermare
Seleccione CONFIGURACIÓN y confirme

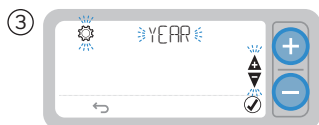

Select YEAR then confirm

Selecteer JAAR en bevestig
Sélectionnez ANNÉE puis confirmez
Wählen Sie JAHR, danach bestätigen
Seleziona ANNO quindi conferma
Seleccione AÑO y luego confirme



Set YEAR then confirm

Stel YEAR in en bevestig vervolgens
Réglez YEAR puis confirmez
JAHR einstellen, danach bestätigen
Imposta anno, quindi conferma
Ajuste AÑO y confirme



Set MONTH (1-12) then confirm

Stel MAAND in (1 - 12) bevestig dan
MONAT (1-12) einstellen, danach bestätigen
Régler le MOIS (1-12) puis confirmez
Impostare il MESE (1 - 12) quindi confermare
Seleccione MES (1-12) luego confirmar

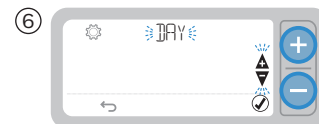

Repeat steps to set DAY, HOUR and MINUTE

Herhaal de stappen om DAG, UUR en MINUUT in te stellen
Répétez les étapes pour régler JOUR, HEURE et MINUTE
Wiederholen Sie die Schritte zum Einstellen von TAG, STUNDE und MINUTE
Ripeti i passi per configurare GIORNO, ORA E MINUTI
Repita los pasos para configurar DÍA, HORA y MINUTO

7

Troubleshooting

Probleemoplossen / Dépannage / Fehlerbehebung /
Risoluzione dei problemi / Resolución de problemas



10% battery power

10% batterijvermogen /
10% de la puissance de la batterie /
10% Batterieleistung /
10% di carica della batteria /
10% de batería

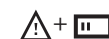

Battery critical low

Batterij bijna leeg /
Batterie critique faible /
Batteriestatus kritisch niedrig /
Bateria quasi scarica /
Bateria críticamente baja

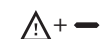

Faulty sensor

Defecte sensor /
Capteur défectueux /
Fehlerhafter Sensor /
Sensore difettoso /
Sensor defectuoso

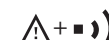

Wireless Signal Loss (T3R Only)

Verlies draadloos signaal (alleen T3R) /
Perte de signal sans fil (T3R seulement) /
Verlust Funksignals (nur T3R) /
Perdita di segnale wireless (solo T3R) /
Pérdida de señal inalámbrica (solo T3R)

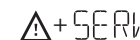

Boiler service reminder (UK Only)

The boiler is due to be serviced. Please contact your landlord or local housing authority.



T3 PROGRAMMABLE THERMOSTAT

EN Quick Start Installation Guide

- NL Installatiehandleiding
- FR Guide d'installation rapide
- DE Kurzinstallationsanleitung
- IT Guida rapida all'installazione
- ES Guía de instalación rápida

Online Guides

Online instructies / Instructions en ligne / Online Anleitung /
Guide online / Instrucciones Online



http://hwll.co/T3_pdfs



Must be installed by a competent person. To ensure your safety make sure the mains power is switched OFF before accessing wiring.

Dient te worden geïnstalleerd door een hiervoor opgeleid persoon. Zorg voor uw veiligheid en schakel de hoofdstroom UIT vóór u begint aan de bedrading.

L'installation doit être réalisée par une personne compétente. Par mesure de sécurité, assurez-vous que l'alimentation électrique générale est coupée avant de toucher à un câble.

Muss von Fachpersonal installiert werden. Zu Ihrer eigenen Sicherheit die Stromversorgung ABSCHALTEN, bevor die Kabel angeschlossen werden.

L'installazione deve essere eseguita da una persona qualificata. Per la vostra sicurezza verificare che la rete elettrica sia staccata prima di accedere al cablaggio.

La instalación debe ser realizada por personal cualificado. Par garantizar su seguridad, asegúrese de que la corriente esté DESCONECTADA antes de acceder a los cables.



To prevent a short circuit from a loose wire:

- **Multi-core cables:** Only remove enough outer insulation to allow secure fixing of the cores into the terminal block.
- **Single core cables:** Secure them together with a cable tie as close as possible to the terminal block.

Vermijd kortsluiting door een losse draad:

- **Bij gebruik van kabels met meerdere aders:** Verwijder niet meer isolatie dan nodig zodat de aders stevig vastgeklemd zitten in het aansluitblok.
- **Bij gebruik van kabels met enkele ader:** Houd ze samen met een kabelbinder, zo dicht mogelijk bij het aansluitblok.

Pour éviter qu'un fil dénudé ne soit à l'origine d'un court-circuit:

- **Si vous utilisez des câbles multibrins :** Ne dénudez le câble que sur la longueur requise pour que les brins puissent être solidement fixés dans le bornier.
- **Si vous utilisez des câbles monobrins :** Liez-les ensemble au moyen d'un collier, aussi près que possible du bornier.

Um einen Kurzschluss aufgrund eines losen Kabelendes zu verhindern:

- **Bei mehradrigen Kabeln:** Nur soviel Außenisolierung entfernen, damit die Kabeladern in der Schraubklemme fixiert werden können.
- **Bei Einzeladern:** So nah wie möglich mit einem Kabelbinder an der Schraubklemme fixieren.

Per evitare un cortocircuito dovuto a un cavo lento:

- **Se si utilizzano cavi multipolari:** Rimuovere soltanto l'isolamento esterno quanto basta per permettere un fissaggio sicuro dei poli nella morsetteria.
- **Se si utilizzano cavi unipolari:** Fissarli insieme con una fascetta per cavi il più vicino possibile alla morsetteria.

Para evitar un cortocircuito debido a un cable suelto:

- **Al utilizar cables de múltiples conductores:** Retire solo el aislante exterior necesario para permitir la conexión segura de los conectores al bloque de terminales.
- **Al utilizar cables de un conductor:** Asegure los cables con una brida para cables lo más cerca posible del bloque de terminales.

1

Install the Thermostat

Installeer de thermostaat / Installer le thermostat / Installieren Sie den Thermostat / Installa il termostato / Instale el termostato

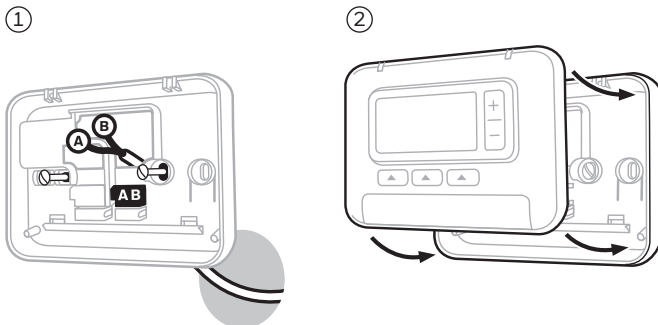
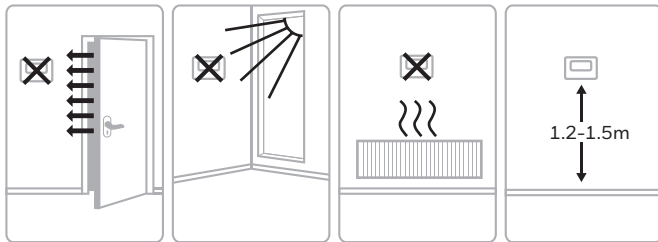

3

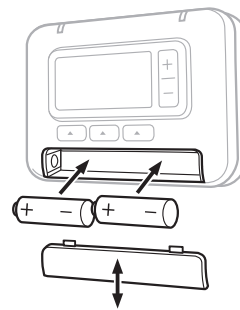

4

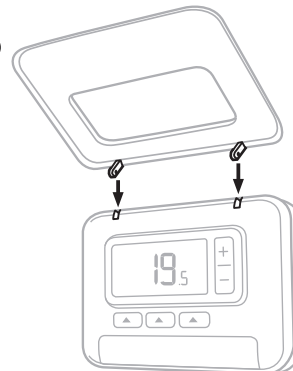

Wiring

Bedrading / Câblage / Verdrahtung / Cablaggio / Cableado

On/off boiler (230V)

Aan/uit cv-ketel
Chaudière classique
Heizkessel OHNE Steuereingang
Caldaia base
Caldera sin contacto para termostato

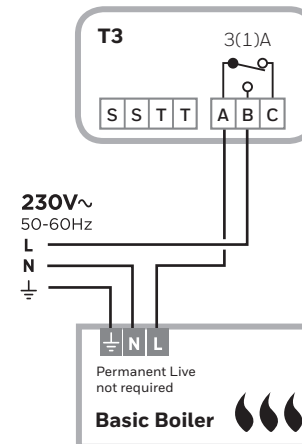

Combi boiler

Aan/uit cv-ketel
Chaudière combinée
Heizkessel MIT Steuereingang
Caldaia combinata
Caldera con contacto para termostato

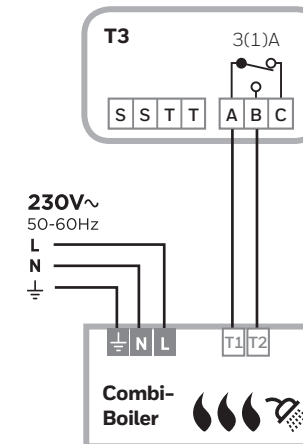

2-Port Zone Valve

2 & 3-wegzoneklep
Vanne de zone 2 ports
Durchgangs-Zonenventil
Valvola di zona a 2 vie
Válvula de zona de 2 vias

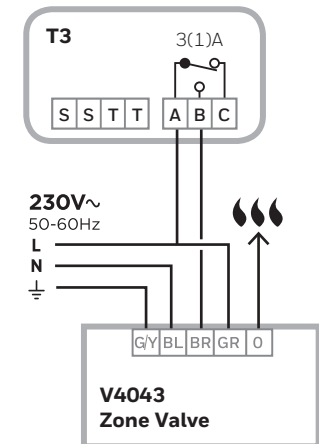

5

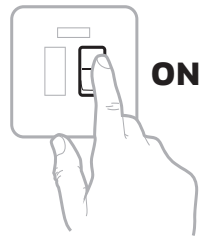

ON

Parameters

Parameters / Paramètres / Parameter / Parametri / Parámetros

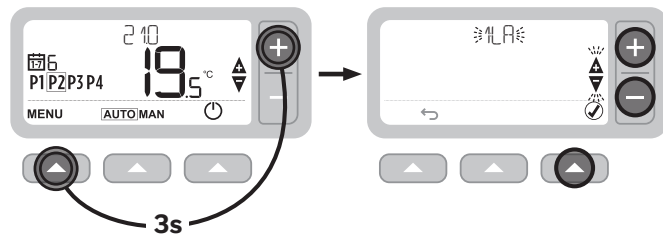

(UK Only) Boiler Service Reminder

To access the service timer parameters:

1. Press and hold the and **+** buttons together for 3 seconds.
2. Enter the PIN (default = **1234**) by selecting 0 to 9 for each of the four segments and press to confirm.
3. OK will be displayed once the correct PIN is entered.

To set the service timer:

1. Press to select the parameter you would like adjust
2. Press **+** or **-** to adjust the parameter and press to confirm
3. Follow the same step for the rest of the parameters or press to exit the service timer.

No	Description	Settings*	Notes
SR1	Enable or disable service reminder	0 = Disabled. 1 = Enabled	
SR2	Number of months until next service	0 to 48 months	Adjust the number of months by pressing + or -. Press tick to confirm.
SR3	Number of days prior alert	0 to 28	Adjust the number of days by pressing + or -. Press tick to confirm.
SR4	Action take after reminder time out	0 = No action 1 = Switch off 2 = Prompt mode	
SR5	Number of EXTRA HOUR presses allowed.	UL = Unlimited 1 - 99	Toggle through "UL" and then 1-99 by pressing + or -. If the user exceeds the limit the Thermostat will switch off.
SR6	Reset settings	0 1 = Reset	Setting to 1 resets all service reminder options to default values
SR7	Change PIN	----	Enter the new PIN by selecting 0 to 9 for each of the four segments

* Default value in bold

No	Description	Settings
1LA	Language / Taal / Langue / Sprache / Lingua / Idioma	1=EN, 2=NL, 3=FR, 4=DE, 5=IT, 6=ES
2CR	Cycle Rate / Snelheidverwarmingscyclus / Cycle de chauffage / Aufheiz-Zyklusrate / Frequenza ciclo di riscaldamento / Frecuencia de los ciclos	1, 3, 6, 9, 12
3OT	Min. On Time / Min. per tijdsduur / Durée minimale de marche / Min. Einschaltzeit / Tempo minimo di accensione / Tiempo mínimo de encendido	1- 5min
4LL	Lower Limit / Laagste temperatuurlimiet / Limite inférieure / Untere Temperaturgrenze / Limite inferiore / Limite inferior	5 - 21 °C
5UL	Upper Limit / Hoogste temperatuurlimiet / Limite supérieure de / Obere Temperaturgrenze / Limite superiore / Limite superior	21 - 35 °C
6SO	Schedule / Programmeopties / Options de programme / Zeitplan-Optionen / Programmazione / Programación	1 = 7 Day / Dag / Jour / Tag / Giorno / Dia 2 = 5+2
8SS	Wired Sensor / Externe sensor / Sonde déportée / Verdrahteter Sensor / Sensore Esterno / Sensor remoto	0 = Disabled / Deactiveren / Désactivé / Deaktivierte / Disattivare / Desactivado 1 = Enabled / Activeren / Activé / Aktivieren / Attivare / Activado
9LC	Fail Safe / Failsafe modus / Mode Sécurité / Störungssicherer Modus / Modalità di autoprotezione / Modo a prueba de fallos	0 = Disabled / Deactiveren / Désactivé / Deaktivierte / Disattivare / Desactivado 1 = Enabled / Activeren / Activé / Aktivieren / Attivare / Activado
10BL	Backlight / Achtergrondverlichting / Rétroéclairage / Hintergrundbeleuchtung / Retroilluminazione / Retroiluminación	0 = Disabled / Deactiveren / Désactivé / Deaktivierte / Disattivare / Desactivado 1 = Enabled / Activeren / Activé / Aktivieren / Attivare / Activado
11CL	Clock / Tijdaanduiding / Format horaire / Uhrzeitformat / Formato orologio / Formato del reloj	0 = 24h 1 = 12h
12DS	Daylight Saving / Zomer-/wintertijd / Heure d'été / So-/Wi-Zeitmstellung / Ora legale / Cambio de hora en horario de verano	0 = Disabled / Deactiveren / Désactivé / Deaktivierte / Disattivare / Desactivado 1 = Enabled / Activeren / Activé / Aktivieren / Attivare / Activado
13TO	Temp. Offset / Afwijking temperatuurweergave / Calibrage sonde / Offset für Temperaturanzeige / Offset temperatura / Compensación de temperatura en pantalla	- 3 / + 3 °C
15SD	Reset Schedule / Terugzetten standaardprogrammering / Réinitialisation programmation / Standard-Zeitplaneinstellungen wiederherstellen / Ripristina programmazione / Restaurar programación	0 1 = Reset / Resetten / Réinitialisation / Zurücksetzen / Ripristina / Restaurar
16FS	Factory Reset / Terugzetten naar fabrieksinstellingen / Rétablissement des réglages usine / Werkseinstellungen wiederherstellen / Ripristina impostazioni di fabbrica / Restaurar valores de fábrica	0 1 = Reset / Resetten / Reset / Zurücksetzen / Ripristina / Restaurar
17OP	Optimum Start / Optimale start / Départ optimisé / Einschaltoptimierung / Avvio ottimale / Arranque óptimo	0 = Deactivate / Deactiveren / Désactiver / Deaktivierte / Disattivare / Desactivado 1 = Optimum Start / Optimale start / Départ optimum / Optimaler Start / Avvio ottimale / Arranque óptimo 2 = Delayed Start / Uitgestelde start / Départ retardé / Verzögerter start / Avvio ritardato / Arranque retardado
18OS	Optimum Stop / Optimale stop / Arrêt optimisé / Abschaltoptimierung / Arresto ottimale / Parada óptima	0 = Disabled / Deactiveren / Désactivé / Deaktivierte / Disattivare / Desactivado 1 = Enabled / Activeren / Activé / Aktivieren / Attivare / Activado
19LK	Lock Options / slot opties / options de verrouillage / Sperroptionen / Opzioni di blocco / Opciones de bloqueo	1 = Partial / Deels / Partiel / Teilweise / Parziale / Bloq parcial 2 = Full / Volledig / Totalement / Vollständig / Completo / Bloq total

EN

Manufactured for and on behalf of the Environmental & Energy Solutions Division of Honeywell Technologies Sàrl, E&ES, Z.A., La Pièce 16, 1180 Rolle, Switzerland by its Authorised Representative Honeywell Inc.

Conforms to protection requirements of the following directives:
EMC: 2014/30/EU,
LVD: 2014/35/EU.

The full text of the EU Declaration of Conformity is available at the following Internet address:
<http://hwl.co/DoC>

WEEE Directive 2012/19/EU

At the end of the product life dispose of the packaging and product in a corresponding recycling centre. Do not dispose of the unit with the usual domestic refuse. Do not burn the product.



DE

Hergestellt für und im Namen der Environmental & Energy Solutions Division von Honeywell Technologies Sàrl, E&ES, Z.A., La Pièce 16, 1180 Rolle, Schweiz, durch seinen bevollmächtigten Vertreter Honeywell Inc.

Entspricht den Schutzanforderungen der folgenden Richtlinien:
EMC: 2014/30/EU,
LVD: 2014/35/EU.

Der ist unter folgenden Internetadresse verfügbar:
<http://hwl.co/DoC>

EEAG-Richtlinie 2012/19/EU

Am Ende des Produktlebenszyklus die Verpackung und das Produkt in einem entsprechenden Wertstoffhof entsorgen. Das Produkt nicht im normalen Haushaltsmüll entsorgen. Das Produkt nicht verbrennen.

NL

Vervaardigd voor en in naam van de afdeling Environmental & Energy Solutions van Honeywell Technologies Sàrl, E&ES, Z.A., La Pièce 16, 1180 Rolle, Zwitserland door zijn geautoriseerde vertegenwoordiger Honeywell Inc.

In overeenstemming met de veiligheidsvoorschriften van de volgende richtlijnen:
EMC: 2014/30/EU,
LVD: 2014/35/EU.

De volledige tekst van de verklaring van overeenstemming EU is beschikbaar op het volgende internetadres: <http://hwl.co/DoC>

AEAA richtlijn 2012/19/EU

Breng het product en de verpakking aan het einde van de levenscyclus naar het hier toe bestemde milieupark. Het apparaat niet bij het gewone huisvuil zetten. Het product niet verbranden.

IT

Prodotto a nome e per conto di Environmental & Energy Solutions Division di Honeywell Technologies Sàrl, E&ES, Z.A., La Pièce 16, 1180 Rolle, Svizzera dal Rappresentante Autorizzato Honeywell Inc.

Conforme ai requisiti di protezione stabiliti dalle seguenti direttive:
EMC: 2014/30/EU,
LVD: 2014/35/EU.

Il testo integrale della dichiarazione di conformità CE è disponibile al seguente indirizzo internet:
<http://hwl.co/DoC>

Direttiva RAEE 2012/19/EU

Al termine del ciclo di vita del prodotto, smaltire l'imballaggio e il prodotto stesso presso un centro di raccolta per il riciclaggio appropriato. Non smaltire l'unità insieme ai normali rifiuti domestici. Non bruciare il prodotto.

FR

Fabriqu  pour et pour le compte de Environmental & Energy Solutions Division de Honeywell Technologies Sàrl, E&ES, Z.A., La Pièce 16, 1180 Rolle, Suisse, par son représentant autorisé Honeywell Inc.

Conforme aux exigences de protection des directives suivantes:
EMC: 2014/30/EU,
LVD: 2014/35/EU.

Le texte intégral de la déclaration de conformité de l'UE est disponible à l'adresse Internet suivante: <http://hwl.co/DoC>

DEEE Directive 2012/19/EU

À la fin de la vie du produit, déposez-le, ainsi que son emballage, dans un centre de recyclage. Ne vous débarrassez pas du produit comme s'il s'agissait d'ordures ménagères. Ne jetez pas le produit dans un feu



T3R PROGRAMMABLE THERMOSTAT

EN Quick Start Installation Guide

- NL Installatiehandleiding
- FR Guide d'installation rapide
- DE Kurzinstructionsanleitung
- IT Guida rapida all'installazione
- ES Guía de instalación rápida

Online Guides

Online instructies / Instructions en ligne / Online Anleitung / Guide online / Instrucciones Online



http://hwll.co/T3_pdfs



Must be installed by a competent person. To ensure your safety make sure the mains power is switched OFF before accessing wiring.

Dient te worden geïnstalleerd door een hiervoor opgeleid persoon. Zorg voor uw veiligheid en schakel de hoofdstroom UIT vóór u begint aan de bedrading.

L'installation doit être réalisée par une personne compétente. Par mesure de sécurité, assurez-vous que l'alimentation électrique générale est coupée avant de toucher à un câble.

Muss von Fachpersonal installiert werden. Zu Ihrer eigenen Sicherheit die Stromversorgung ABSCHALTEN, bevor die Kabel angeschlossen werden.

L'installazione deve essere eseguita da una persona qualificata. Per la vostra sicurezza verificare che la rete elettrica sia staccata prima di accedere al cablaggio.

La instalación debe ser realizada por personal cualificado. Par garantizar su seguridad, asegúrese de que la corriente esté DESCONECTADA antes de acceder a los cables.



To prevent a short circuit from a loose wire:

- **Multi-core cables:** Only remove enough outer insulation to allow secure fixing of the cores into the terminal block.
- **Single core cables:** Secure them together with a cable tie as close as possible to the terminal block.

Vermijd kortsluiting door een losse draad:

- **Bij gebruik van kabels met meerdere aders:** Verwijder niet meer isolatie dan nodig zodat de aders stevig vastgeklemd zitten in het aansluitblok.
- **Bij gebruik van kabels met enkele ader:** Houd ze samen met een kabelbinder, zo dicht mogelijk bij het aansluitblok.

Pour éviter qu'un fil dénudé ne soit à l'origine d'un court-circuit:

- **Si vous utilisez des câbles multibrins :** Ne dénudez le câble que sur la longueur requise pour que les brins puissent être solidement fixés dans le bornier.
- **Si vous utilisez des câbles monobrins :** Liez-les ensemble au moyen d'un collier, aussi près que possible du bornier.

Um einen Kurzschluss aufgrund eines losen Kabelendes zu verhindern:

- **Bei mehradrigen Kabeln:** Nur soviel Außenisolierung entfernen, damit die Kabeladern in der Schraubklemme fixiert werden können.
- **Bei Einzeladern:** So nah wie möglich mit einem Kabelbinder an der Schraubklemme fixieren.

Per evitare un cortocircuito dovuto a un cavo lento:

- **Se si utilizzano cavi multipolari:** Rimuovere soltanto l'isolamento esterno quanto basta per permettere un fissaggio sicuro dei poli nella morsetteria.
- **Se si utilizzano cavi unipolari:** Fissarli insieme con una fascetta per cavi il più vicino possibile alla morsetteria.

Para evitar un cortocircuito debido a un cable suelto:

- **Al utilizar cables de múltiples conductores:** Retire solo el aislante exterior necesario para permitir la conexión segura de los conectores al bloque de terminales.
- **Al utilizar cables de un conductor:** Asegure los cables con una brida para cables lo más cerca posible del bloque de terminales.

1

Install the Relay Box

Install the Relay Box / Bedragen van de RF module / Câblage de la boîte de réception / Empfängerbox verdrahten / Installare il relè / Cablee la caja de recepción

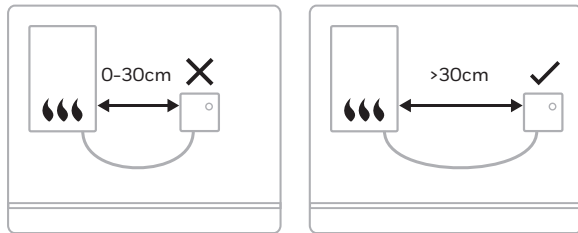

1 A

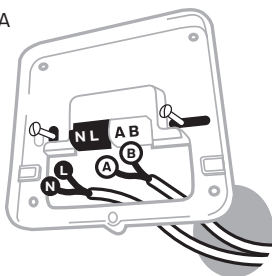

B

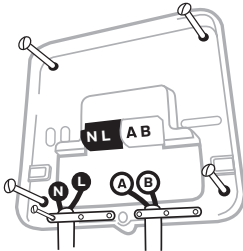

2

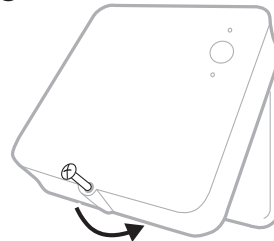

3

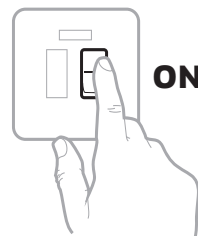

Wiring

Wiring / Bedrading / Câblage / Verdrahtung / Cablaggio / Cableado

On/off boiler (230V)

Aan/uit cv-ketel
Chaudière classique
Heizkessel OHNE Steuereingang
Caldaia base
Caldera sin contacto para termostato

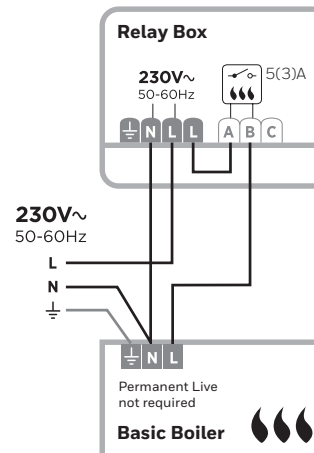

Combi boiler

Aan/uit cv-ketel
Chaudière combinée
Heizkessel MIT Steuereingang
Caldaia combinata
Caldera con contacto para termostato

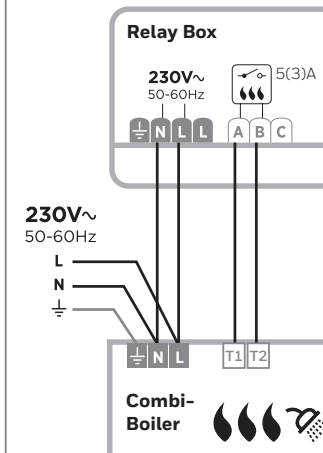

2-Port Zone Valve

2 & 3-wegzoneklep
Vanne de zone 2 ports
Durchgangs-Zonenventil
Valvola di zona a 2 vie
Válvula de zona de 2 vías

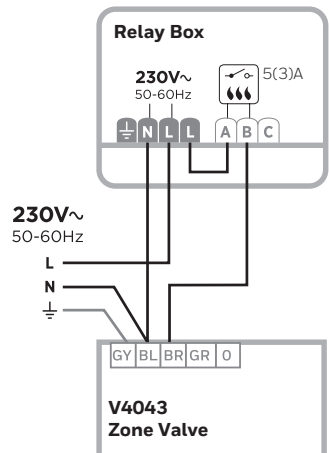

2

Install the Thermostat

Installeer de thermostaat / Installer le thermostat / Installieren Sie den Thermostat / Installa il termostato / Instale el termostato

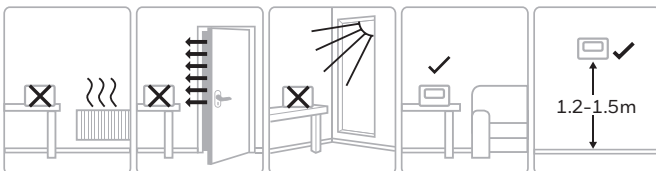

The Thermostat and Relay Box in this pack are pre-bound.

De thermostat en RF module in deze verpakking zijn al aan elkaar toegewezen.

Communication sans fil est préétablie entre le thermostat et le boîtier relais.

Der Thermostat und die Empfängerbox in dieser Packung sind durch werkseitige Kopplung bereits miteinander verbunden.

Il termostato e il modulo relé Incluso sono pre-associati.

El termostato y el receptor de este pack están vinculados.

①

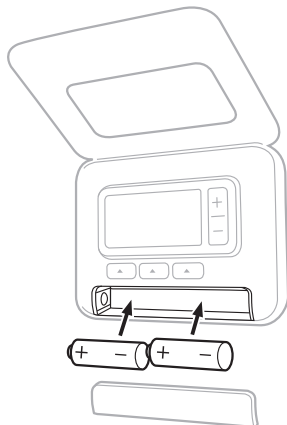

(UK Only) Boiler Service Reminder

To access the service timer parameters:

1. Press and hold the and buttons together for 3 seconds.
2. Enter the PIN (default = 1234) by selecting 0 to 9 for each of the four segments and press to confirm.
3. OK will be displayed once the correct PIN is entered.

To set the service timer:

1. Press to select the parameter you would like adjust
2. Press or to adjust the parameter and press to confirm
3. Follow the same step for the rest of the parameters or press to exit the service timer.

No	Description	Settings*	Notes
SR1	Enable or disable service reminder	0 = Disabled. 1 = Enabled	
SR2	Number of months until next service	0 to 48 months	Adjust the number of months by pressing + or -. Press tick to confirm.
SR3	Number of days prior alert	0 to 28	Adjust the number of days by pressing + or -. Press tick to confirm.
SR4	Action take after reminder time out	0 = No action 1 = Switch off 2 = Prompt mode	
SR5	Number of EXTRA HOUR presses allowed.	UL = Unlimited 1 - 99	Toggle through "UL" and then 1-99 by pressing + or -. If the user exceeds the limit the Thermostat will switch off.
SR6	Reset settings	0 1 = Reset	Setting to 1 resets all service reminder options to default values
SR7	Change PIN	----	Enter the new PIN by selecting 0 to 9 for each of the four segments

* Default value in bold

Parameters

Parameters /
Paramètres /
Parameter /
Parameteri /
Parámetros

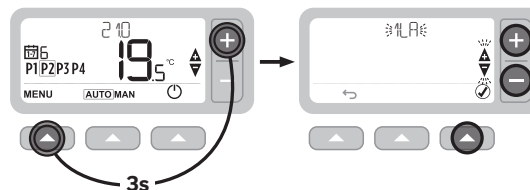

No	Description	Settings
1LA	Language / Taal / Langue / Sprache / Lingua / Idioma	1=EN, 2=NL, 3=FR, 4=DE, 5=IT, 6=ES
2CR	Cycle Rate / Snelheidverwarmingscyclus / Cycle de chauffage / Aufheiz-Zyklusrate / Frecuencia ciclo di riscaldamento / Frecuencia de los ciclos	1, 3, 6, 9, 12
3OT	Min. On Time / Min. per tijdsduur / Durée minimale de marche / Min. Einschaltzeit / Tempo minimo di accensione / Tiempo mínimo de encendido	1-5min
4LL	Lower Limit / Laagste temperatuurlimiet / Limite inférieure / Untere Temperaturgrenze / Limite inférieure / Limite inferior	5 - 21 °C
5UL	Upper Limit / Hoogste temperatuurlimiet / Limite supérieure de / Obere Temperaturgrenze / Limite supérieure / Limite superior	21 - 35 °C
6SO	Schedule / Programmeopties / Options de programme / Zeitplan-Optionen / Programmazione / Programación	1 = 7 Day / Dag / Jour / Tag / Giorno / Dia 2 = 5+2
9LC	Fail Safe / Failsafe modus / Mode Sécurité / Störungssicherer Modus / Modalità di autoprotezione / Modo a prueba de fallos	0 = Disabled / Deactiveren / Désactivé / Deaktiviert / Disattivare / Desactivado 1 = Enabled / Activeren / Activé / Aktivieren / Attivare / Activado
10BL	Backlight / Achtergrondverlichting / Rétroéclairage / Hintergrundbeleuchtung / Retroilluminazione / Retroluminación	0 = Disabled / Deactiveren / Désactivé / Deaktiviert / Disattivare / Desactivado 1 = Enabled / Activeren / Activé / Aktivieren / Attivare / Activado
11CL	Clock / Tijdaanduiding / Format horaire / Uhrzeitformat / Formato orologio / Formato del reloj	0 = 24h 1 = 12h
12DS	Daylight Saving / Zomer-/wintertijd / Heure d'été / Zeitumstellung / Ora legale / Cambio de hora en horario de verano	0 = Disabled / Deactiveren / Désactivé / Deaktiviert / Disattivare / Desactivado 1 = Enabled / Activeren / Activé / Aktivieren / Attivare / Activado
13TO	Temp. Offset / Afwijking temperatuurweergave / Calibrage sonde / Offset für Temperaturanzeige / Offset temperatura / Compensación de temperatura en pantalla	- 3 / + 3 °C
15SD	Reset Schedule / Terugzetten standaardprogrammering / Réinitialisation programmation / Standard-Zeitplaneinstellungen wiederherstellen / Ripristina impostazioni di fabbrica / Restaurar valores de fábrica	0 1 = Reset / Resetten / Rétablir / Zurücksetzen / Ripristina / Restaurar
16FS	Factory Reset / Terugzetten naar fabrieksinstellingen / Rétablissement des réglages usine / Werkseinstellungen wiederherstellen / Ripristina impostazioni di fabbrica / Restaurar valores de fábrica	0 1 = Reset / Resetten / Rétablir / Zurücksetzen / Ripristina / Restaurar
17OP	Optimum Start / Optimale start / Départ optimisé / Einschaltoptimierung / Avvio ottimale / Arranque óptimo	0 = Disabled / Deactiveren / Désactivé / Deaktiviert / Disattivare / Desactivado 1 = Optimum Start / Optimale start / Départ optimisé / Avvio ottimale / Arranque óptimo 2 = Delayed Start / Uitgestelde start / Départ retardé / Verzogert start / Avvio ritardato / Arranque retardado
18OS	Optimum Stop / Optimale stop / Arrêt optimisé / Abschaltoptimierung / Arresto ottimale / Parada óptima	0 = Disabled / Deactiveren / Désactivé / Deaktiviert / Disattivare / Desactivado 1 = Enabled / Activeren / Activé / Aktivieren / Attivare / Activado
19LK	Lock Options / slot opties / options de verrouillage / Sperroptionen / Opzioni di blocco / Opciones de bloqueo	1 = Partial / Deels / Partiel / Teilweise / Parziale / Bloq parcial 2 = Full / Volledig / Totalemt / Vollständig / Completo / Bloq total

EN

Manufactured for and on behalf of the Environmental & Energy Solutions Division of Honeywell Technologies Sàrl, E&ES, Z.A., La Pièce 16, 1180 Rolle, Switzerland by its Authorised Representative Honeywell Inc.

Conforms to protection requirements of the following directives: EMC:2014/30/EU, LVD:2014/35/EU, R.E.D.: 2014/53/EU.

Hereby, Honeywell declares that this product is in compliance with the essential requirements and other relevant provisions of Directive 2014/53/EU. The full text of the EU Declaration of Conformity is available at the following Internet address: <http://hwll.co/DoC>

RF (868MHz)

Receiver Category 2
Max RF Power: 25mW
868-868.6MHz (868.3MHz)

WEEE Directive 2012/19/EU

At the end of the product life dispose of the packaging and product in a corresponding recycling centre. Do not dispose of the unit with the usual domestic refuse. Do not burn the product.



DE

Hergestellt für und im Namen der Environmental & Energy Solutions Division von Honeywell Technologies Sàrl, E&ES, Z.A., La Pièce 16, 1180 Rolle, Schweiz, durch seinen bevollmächtigten Vertreter Honeywell Inc.

Entspricht den Schutzanforderungen der folgenden Richtlinien: EMC: 2014/30/EU, LVD: 2014/35/EU, R.E.D.: 2014/53/EU.

Honeywell erklärt hiermit, dass das Produkt mit den grundlegenden Anforderungen sowie sonstigen einschlägigen Bestimmungen der Richtlinie 2014/53/EU übereinstimmt. Der ist unter folgenden Internetadresse verfügbar: <http://hwll.co/DoC>

RF (868MHz)

Empfängerkategorie 2
Maximale RF Kraft: 25mW
868-868.6MHz (868.3MHz)

EEAG-Richtlinie 2012/19/EU

Am Ende des Produktlebenszyklus die Verpackung und das Produkt in einem entsprechenden Wertstoffhof entsorgen. Das Produkt nicht im normalen Haushaltsmüll entsorgen. Das Produkt nicht verbrennen.

NL

Vervaardigd voor en in naam van de afdeling Environmental & Energy Solutions van Honeywell Technologies Sàrl, E&ES, Z.A., La Pièce 16, 1180 Rolle, Zwitserland door zijn geautoriseerde vertegenwoordiger Honeywell Inc.

In overeenstemming met de veiligheidseisen van de volgende richtlijnen: EMC: 2014/30/EU, LVD: 2014/35/EU, R.E.D.: 2014/53/EU.

Honeywell verklaart hierbij dat deze product voldoet aan de essentiële vereisten en andere relevante voorschriften van de richtlijn 2014/53/EU. De volledige tekst van de verklaring van overeenstemming EU is beschikbaar op het volgende internetadres: <http://hwll.co/DoC>

RF (868MHz)

Ontvanger categorie 2
Puisissance RF Max: 25mW
868-868.6MHz (868.3MHz)

AEAA richtlijn 2012/19/EU

Breng het product en de verpakking aan het einde van de levenscyclus naar het hier toe bestemde milieupark. Het apparaat niet bij het gewone huishuif zetten. Het product niet verbranden.

FR

Fabriqué pour et pour le compte de Environmental & Energy Solutions Division de Honeywell Technologies Sàrl, E&ES, Z.A., La Pièce 16, 1180 Rolle, Suisse, par son représentant autorisé Honeywell Inc.

Conforme aux exigences de protection des directives suivantes: EMC: 2014/30/EU, LVD: 2014/35/EU, R.E.D.: 2014/53/EU.

Honeywell déclare ici que ce produit est conforme aux exigences essentielles et dispositions concernées de la Directive 2014/53/EU. Le texte intégral de la déclaration de conformité de l'UE est disponible à l'adresse Internet suivante: <http://hwll.co/DoC>

RF (868MHz)

Catégorie du récepteur 2
Puisissance RF Max: 25mW
868-868.6MHz (868.3MHz)

DEEE Directive 2012/19/EU

À la fin de la vie du produit, déposez-le, ainsi que son emballage, dans un centre de recyclage. Ne vous débarrassez pas du produit comme s'il s'agissait d'ordures ménagères. Ne jetez pas le produit dans un feu

IT

Prodotto a nome e per conto di Environmental & Energy Solutions Division di Honeywell Technologies Sàrl, E&ES, Z.A., La Pièce 16, 1180 Rolle, Svizzera dal Rappresentante Autorizzato Honeywell Inc.

Conforme ai requisiti di protezione stabiliti dalle seguenti direttive: EMC: 2014/30/EU, LVD: 2014/35/EU, R.E.D.: 2014/53/EU.

Con la presente, Honeywell, dichiara che questo prodotto è conforme ai requisiti fondamentali e ad altre disposizioni pertinenti della Direttiva 2014/53/EU. Il testo integrale della dichiarazione di conformità CE è disponibile al seguente indirizzo internet: <http://hwll.co/DoC>

RF (868MHz)

Categoria ricevitore 2
Potenza RF massima: 25mW
Poder maximo RF: 25mW
868-868.6MHz (868.3MHz)

Direttiva RAEE 2012/19/EU

Al termine del ciclo di vita del prodotto, smaltire l'imballaggio e il prodotto stesso presso un centro di raccolta per il riciclaggio appropriato. Non smaltire l'unità insieme ai normali rifiuti domestici. Non bruciare il prodotto.

ES

Fabricado para y en nombre de la división Environmental & Energy Solutions de Honeywell Technologies Sàrl, E&ES, Z.A., La Pièce 16, 1180 Rolle, Suiza por su representante autorizado Honeywell Inc.

Cumple los requisitos de protección de las siguientes directivas: EMC: 2014/30/EU, LVD: 2014/35/EU, R.E.D.: 2014/53/EU.

Por el presente documento, Honeywell declara que este producto cumple los requisitos esenciales y otras provisiones relevantes de la Directiva 2014/53/EU. El texto completo de la Declaración de conformidad de la UE está disponible en la siguiente dirección de Internet: <http://hwll.co/DoC>

RF (868MHz)

Categoría del receptor 2
Potencia máxima RF: 25mW
868-868.6MHz (868.3MHz)

Directiva WEEE 2012/19/EU

Al final la vida del producto, deseche el embalaje y el producto en el correspondiente centro de reciclado. No deseche la unidad con los residuos domésticos normales. No quemar el producto.