



Braukmann V6000A Kombi-F-II, Kombi F

Flanged balancing and shut-off valve with Safecon™ measuring connections

APPLICATION

The hydronic balance is a significant requirement for the efficient operation of a hydronic heating or cooling installation. In an unbalanced system under or over provision of hot water to individual radiators or circuits can occur. Apart from the correct selection of radiator valves, regulation of individual circuits is also necessary and in some cases, such as in DIN 18380, VOB part C, required by national standards.

This requirement is met with Kombi-F-II and Kombi-F shut-off and balancing valves.

Kombi-F-II and Kombi-F have functions shut-off, presetting and measuring.

SPECIAL FEATURES

- Balancing through stroke limitation with digital presetting and visible presetting indicator
- Equipped with 2 pressure test cocks for differential pressure measurement (DN25...DN400)
- Non rising spindle with EDD (double sealing system)
- Presetting isn't altered when handwheel is turned
- PTFE-seat sealing
- Spindle made of stainless steel
- Valve body made of corrosion resistant cast iron
- Available in dimensions up to DN400



CE 0525

TECHNICAL DATA

Media	
Medium:	Water, water-glycol mixture
Pressure values	
Max. operating pressure:	16 bar for DN15 to DN300 14 bar for DN350 12 bar for DN400
Operating temperatures	
Water:	-10 - 120 °C (14 - 248 °F)
Water-glycol mixtures:	-10 - 110°C (14 - 230°F)
Connections/Sizes	
k _{VS} (C _{VS})-value:	see table below and flow diagrams

Note: The valves are designed for application not influenced by weather. For application outside or in adverse environments like corrosion-promoting conditions (sea water, chemical vapours, etc.) special constructions or protective measures are recommended.

Note: To avoid stone deposit and corrosion the composition of the medium should conform with VDI-Guideline 2035

Note: Additives have to be suitable for EPDM sealings

Note: System has to be flushed thoroughly before initial operation with all valves fully open

Note: Any complaints or costs resulting from non-compliance with above rules will not be accepted

Note: Please contact us if you should have any special requirements or needs

CONSTRUCTION

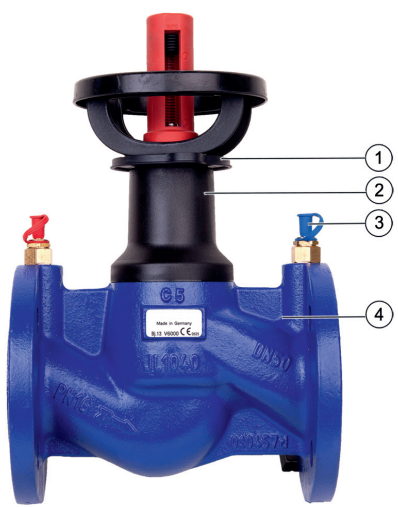
Overview	Components	Materials
	1 Handwheel	PA6 DN65
	2 Fairing	Plastic PA6
	3 Pressure test cocks	Brass
	4 Valve housing	Iron GG25 BL1040 / BS1049
	Not depicted components:	
	Valve insert	Stainless steel

INSTALLATION GUIDELINES

Installation Example

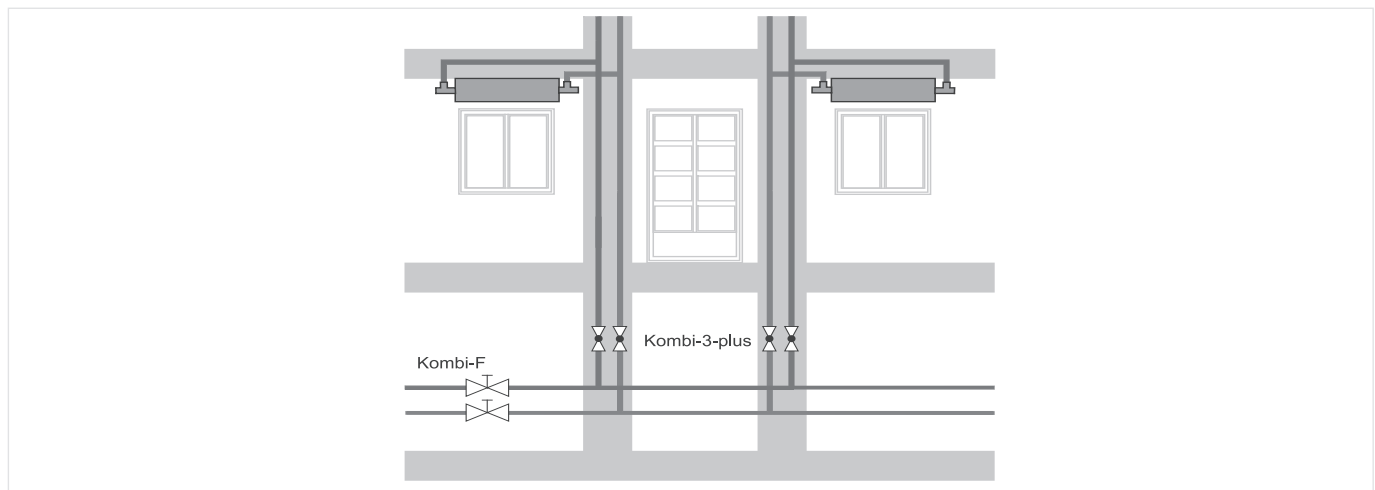

Fig. 1 Kombi - F in a cooling system

TECHNICAL CHARACTERISTICS

Influence of Coolants on Flow Values

The flow through a valve is defined by the kv-value. The kv-value is the flow m through a valve in [m³/h] at a differential pressure of 1 bar (14.5 psi) and is only valid for fluids with a density of $\sigma_0 = 1000 \text{ kg/m}^3$. This condition is met by water at a temperature of 20°C (68°F). For fluids with another density the following formula can be applied:

$$kv_{\text{Medium}} = \frac{m}{\sqrt{\Delta p}} \times \frac{\sqrt{\rho_{\text{Medium}}}}{\sqrt{\rho_0}}$$

Correction factor f

When the density σ is expressed in t/m³ instead of kg/m³ the correction factor f is the result. The correction factor f can be used to re-calculate kv-value, pressure drop and flow:

$$kv_{\text{Medium}} = kv_0 \times \frac{1}{\sqrt{f}} \quad \Delta p_{\text{Medium}} = \Delta p_0 \times f \quad m_{\text{Medium}} = m_0 \times \frac{1}{\sqrt{f}}$$

Medium	water part	Correction factor f					
		5 °C (41 °F)	20 °C (68 °F)	35 °C (95 °F)	50 °C (122 °F)	65 °C (149 °F)	80 °C (176 °F)
Normal water	100 %	1.0	0.998	0.994	0.988	0.981	0.972
Ethylen glycol e.g. Antifrogen N	70 %	1.052	1.047	1.041	1.033	1.024	1.015
	50 %	1.086	1.079	1.070	1.061	1.052	1.042
Propylen glycol e.g. Antifrogen L	70 %	1.035	1.029	1.021	1.012	1.002	0.991
	50 %	1.053	1.044	1.035	1.025	1.014	1.002

kvs-Values Kombi-F-II, DN15

Presetting:	0.5	1.0	1.5	2.0	2.5	3.0	3.5	4.0	4.5	5.0	5.5	6.0	6.5	6.6 = open
k _v -value:	0.13	0.26	0.37	0.55	0.80	1.10	1.50	1.90	2.30	2.60	2.90	3.30	4.20	k _{vS} = 4.50
c _v -value:	0.15	0.30	0.43	0.64	0.94	1.29	1.76	2.22	2.69	3.04	3.39	3.86	4.91	5.27

Flow Data Kombi-F-II, DN15

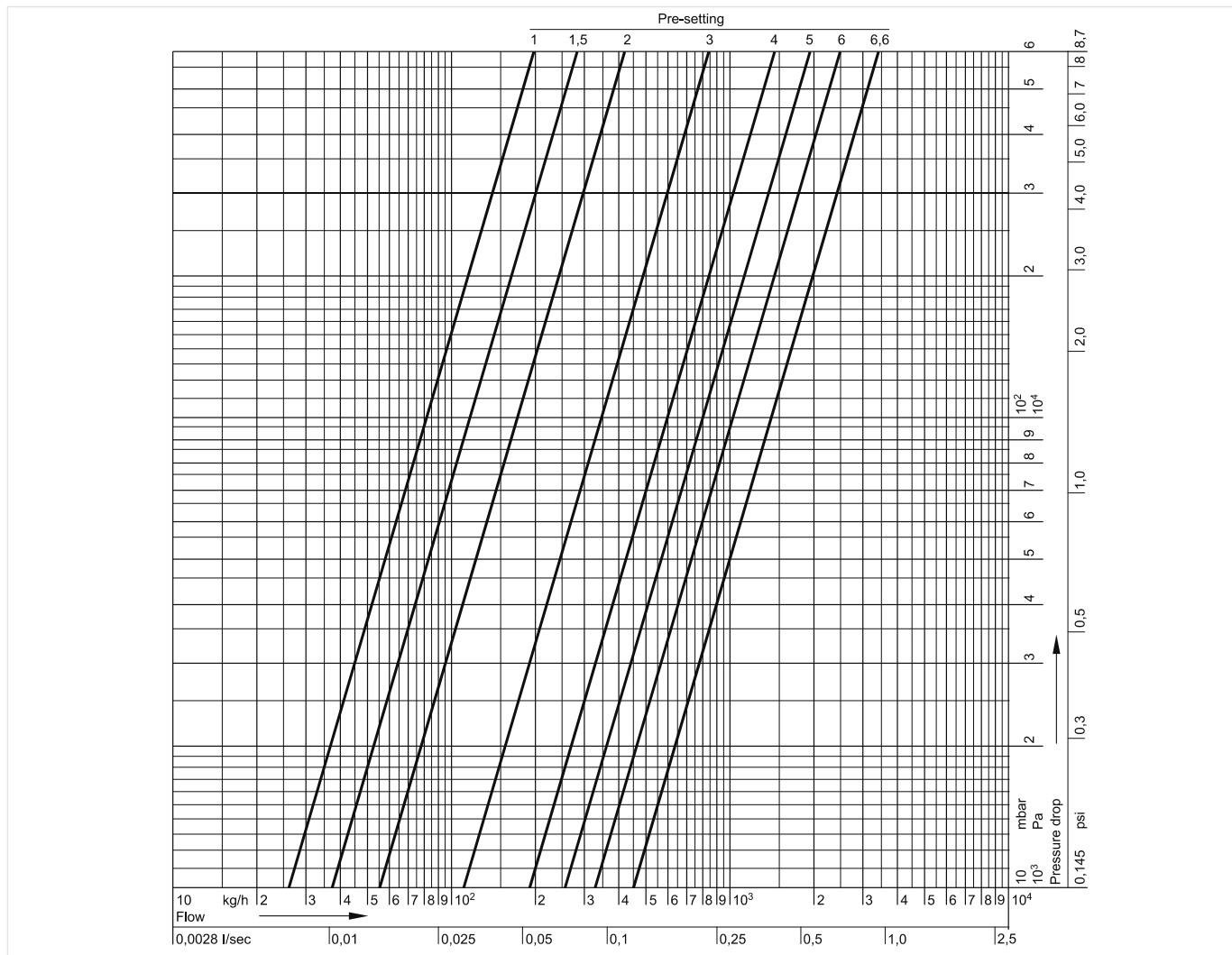

kvs-Values Kombi-F-II, DN20

Pre-setting:	0.5	1.0	1.5	2.0	2.5	3.0	3.5	4.0	4.5	5.0	5.5	6.0	6.5	6.6 = open
k _v -value:	0.22	0.43	0.65	0.90	1.15	1.60	2.06	2.60	3.36	4.00	4.79	5.60	6.43	k _{vS} = 6.60
cv-value:	0.26	0.50	0.76	1.05	1.35	1.87	2.41	3.04	3.81	4.68	5.60	6.55	7.52	7.72

Flow Data Kombi-F-II, DN20

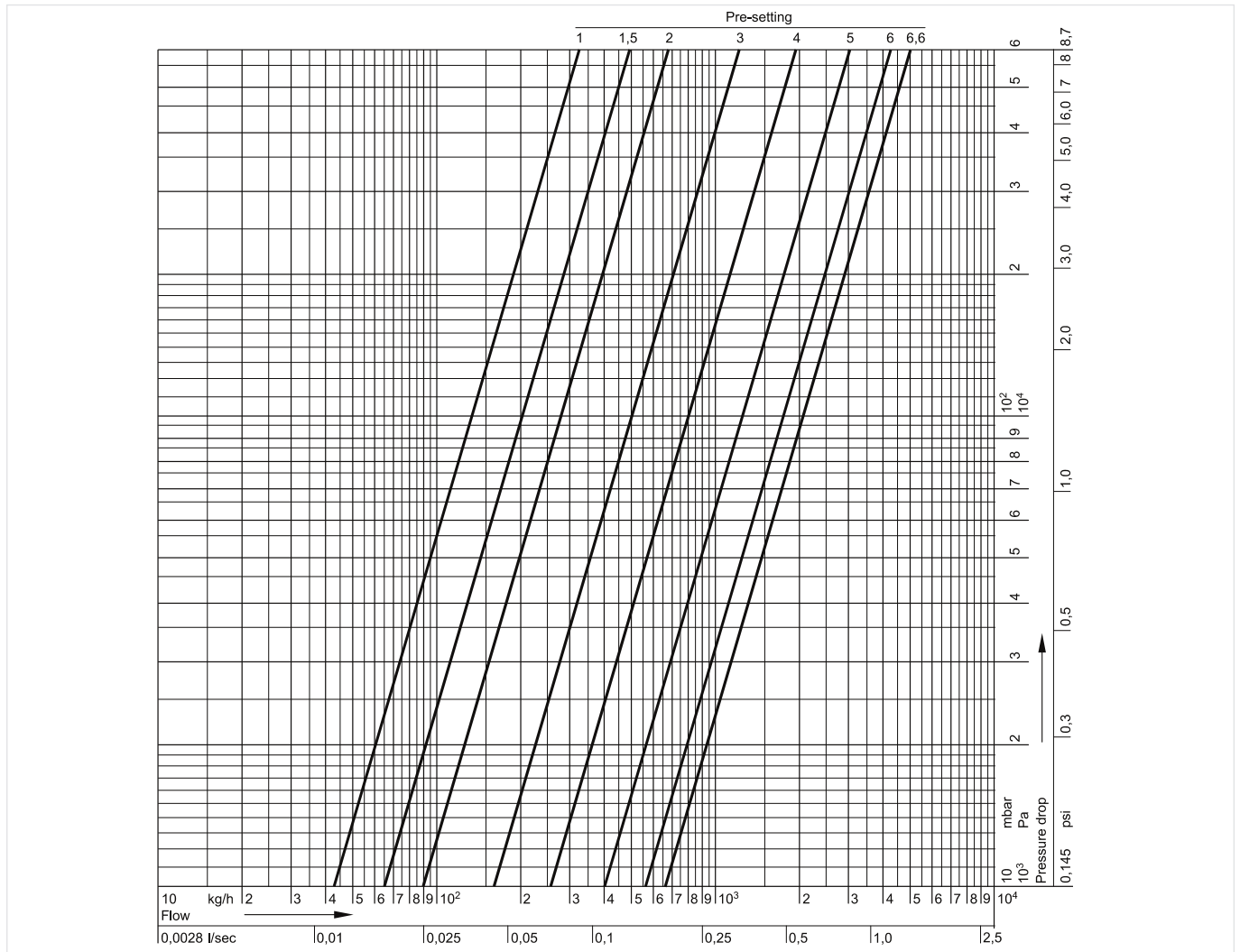

kvs-Values Kombi-F-II, DN25

Presetting:	0.5	1.0	1.5	2.0	2.5	3.0	3.5	4.0	4.5	5.0	5.5	6.0	6.5	6.6 = open
k _v -value:	0.22	0.49	0.84	1.30	1.85	2.50	3.25	4.10	5.07	6.20	7.50	8.70	9.63	k _{vS} = 9.80
c _v -value:	0.26	0.57	0.98	1.52	2.16	2.93	3.80	4.80	5.93	7.25	8.78	10.2	11.3	11.5

Flow Data Kombi-F-II, DN25

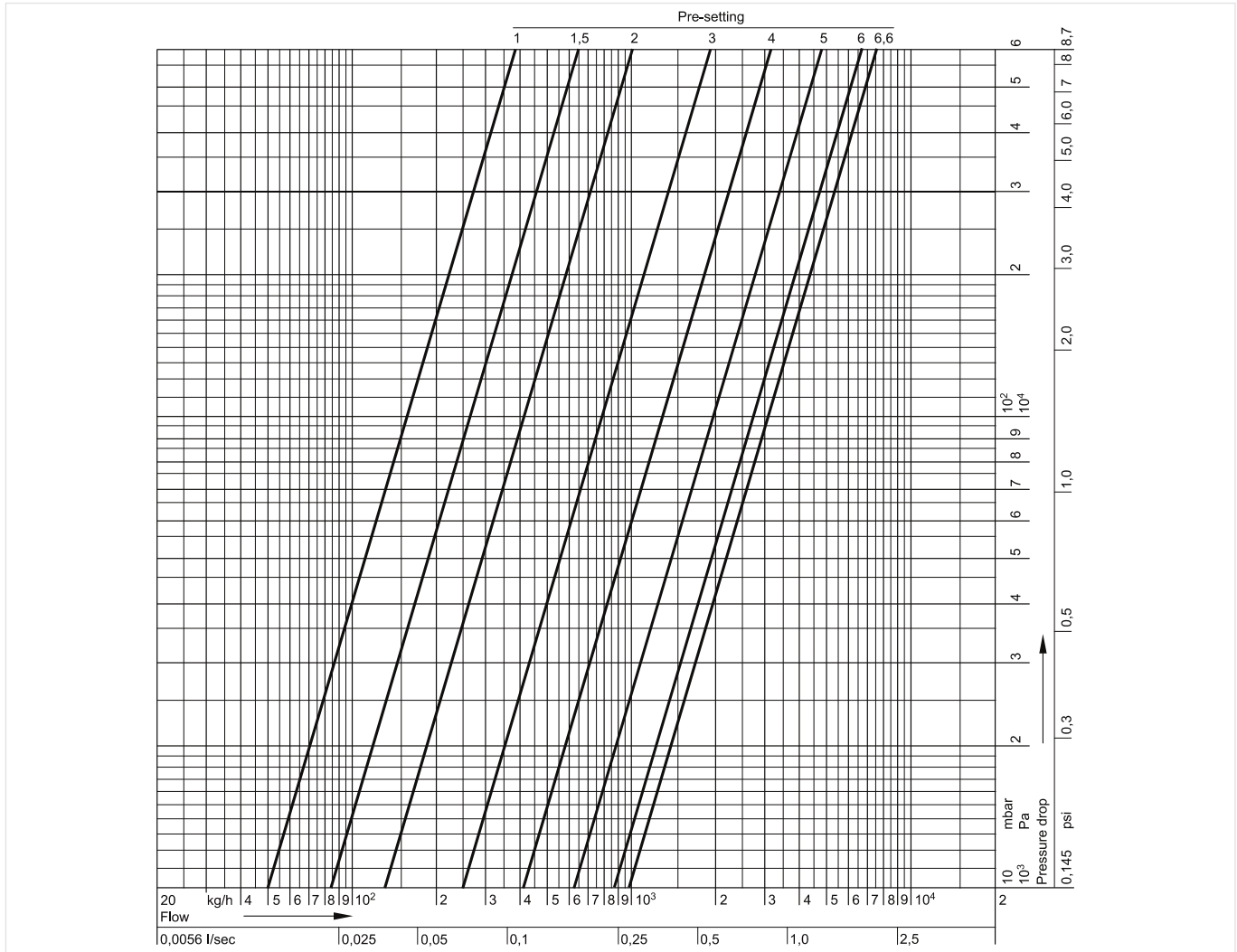

kvs-Values Kombi-F-II, DN32

Presetting:	0.5	1.0	1.5	2.0	2.5	3.0	3.5	4.0	4.5	5.0	5.5	6.0	6.5	6.6 = open
k _v -value:	0.28	0.60	1.06	1.68	2.48	3.54	4.91	6.46	7.97	9.47	11.0	12.8	14.7	k _{vS} = 15.1
cv-value:	0.33	0.70	1.24	1.97	2.90	4.14	5.74	7.56	9.32	11.1	12.9	15.0	17.2	17.7

Flow Data Kombi-F-II, DN32

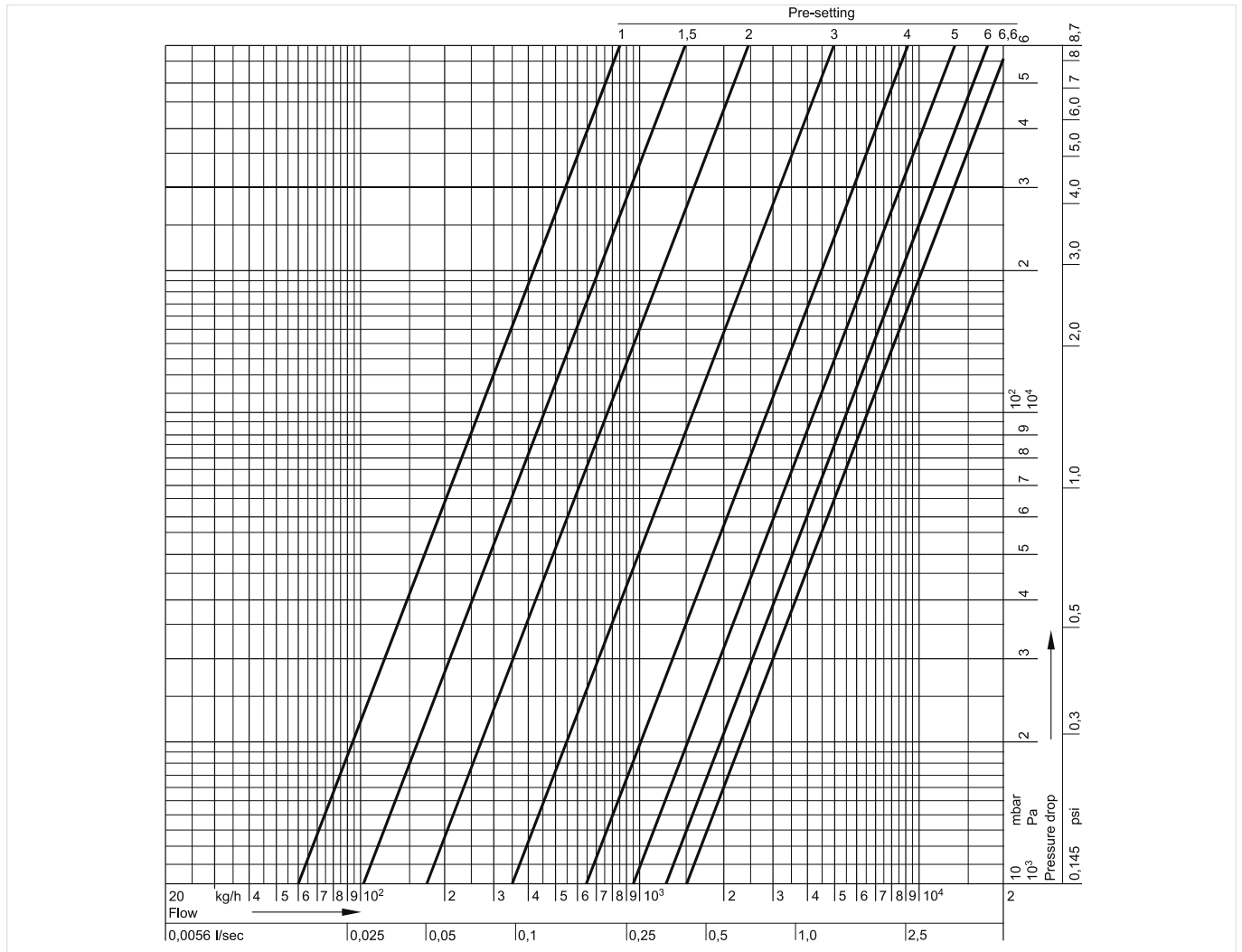

kvs-Values Kombi-F-II, DN40

Pre-setting:	0.5	1.0	1.5	2.0	2.5	3.0	3.5	4.0	4.5	5.0	5.5	6.0	6.5	7.0	7.5 = open
k _v -value:	0.88	1.80	2.80	4.00	5.42	6.90	8.31	9.90	11.9	14.3	16.8	18.8	20.4	22.2	k _{vS} = 9.80
cv-value:	1.03	2.11	3.28	4.68	6.34	8.07	9.72	11.6	13.9	16.7	19.7	22.0	23.9	26.0	29.1

Flow Data Kombi-F-II, DN40

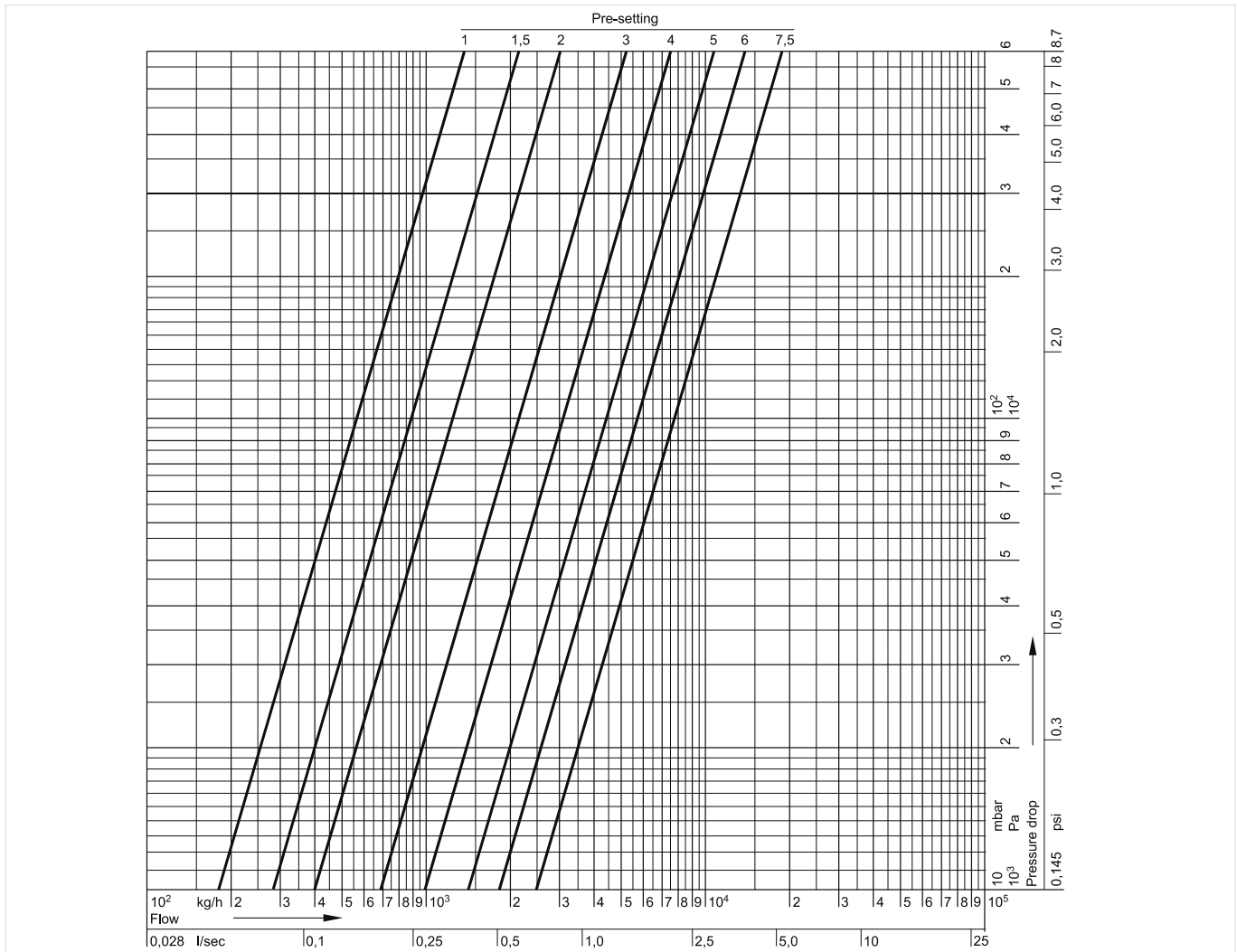

kvs-Values Kombi-F-II, DN50

Pre-setting:	0.5	1.0	1.5	2.0	2.5	3.0	3.5	4.0	4.5	5.0	5.5	6.0	6.5	7.0	7.5 = open
k _v -value:	1.07	2.20	3.46	5.10	7.36	10.3	13.9	18.05	22.7	28.0	34.1	39.3	42.8	45.6	k _{vs} = 48.5
cv-value:	1.25	2.57	4.05	5.97	8.61	12.1	16.3	20.99	26.6	32.8	39.9	46.0	50.1	53.4	56.7

Flow Data Kombi-F-II, DN50

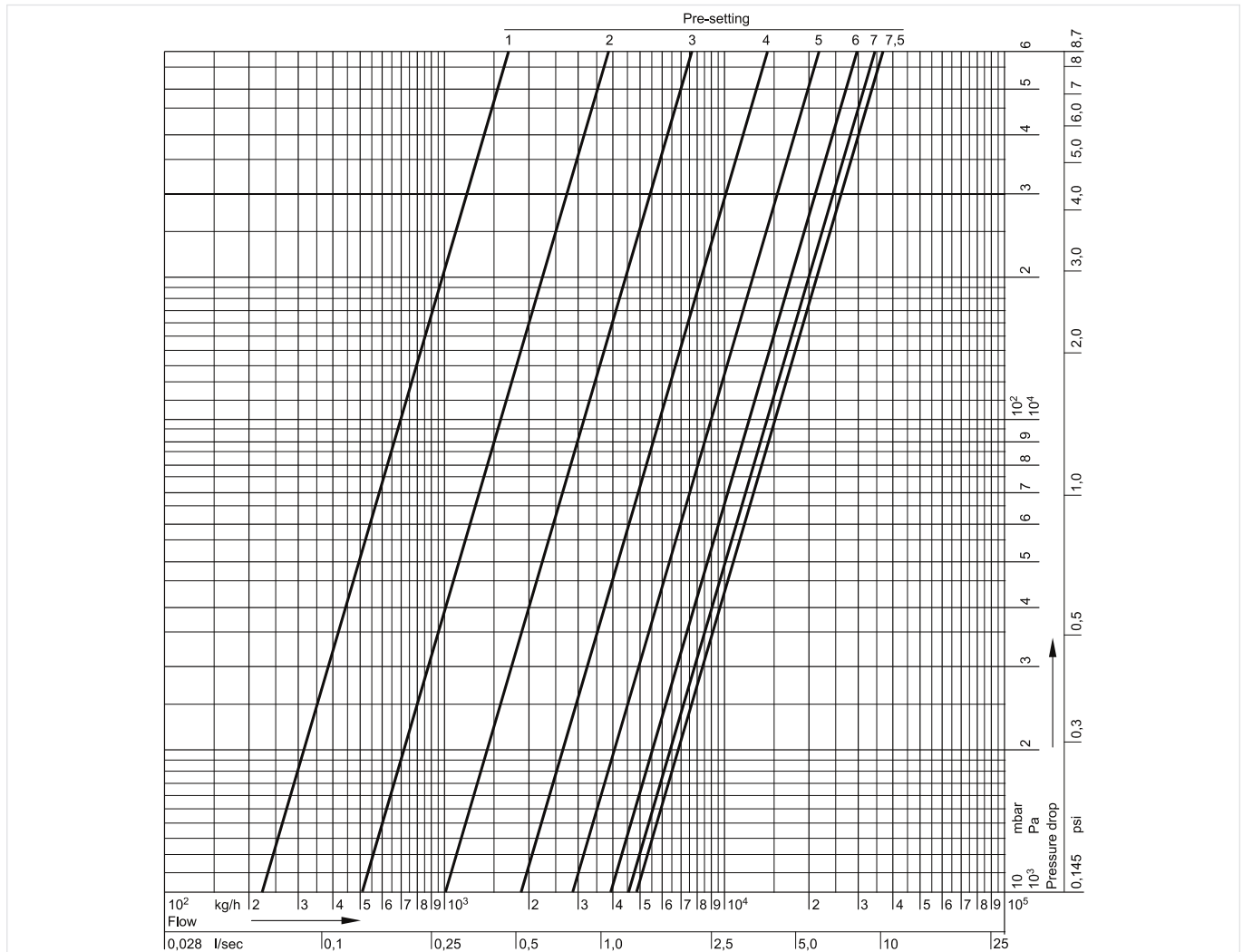

kvs-Values Kombi-F-II, DN65

Presetting:	0.5	1.0	1.5	2.0	2.5	3.0	3.5	4.0	4.5	5.0	5.5	6.0	6.5	7.0	7.5
k _v -value:	2.98	5.30	6.64	7.80	9.60	12.1	15.2	19.0	23.6	29.1	35.2	41.3	47.0	52.1	56.6
cv-value:	3.49	6.20	7.77	9.13	11.2	14.2	17.8	22.2	27.6	34.0	41.2	48.3	55.0	61.0	65.81

Presetting:	8.0	8.5	9.0	9.5	10.0 = open
k _v -value:	60.7	64.4	67.9	71.2	k _{vS} = 74.4
cv-value:	71.0	74.88	79.4	82.79	87.0

Flow Data Kombi-F-II, DN65

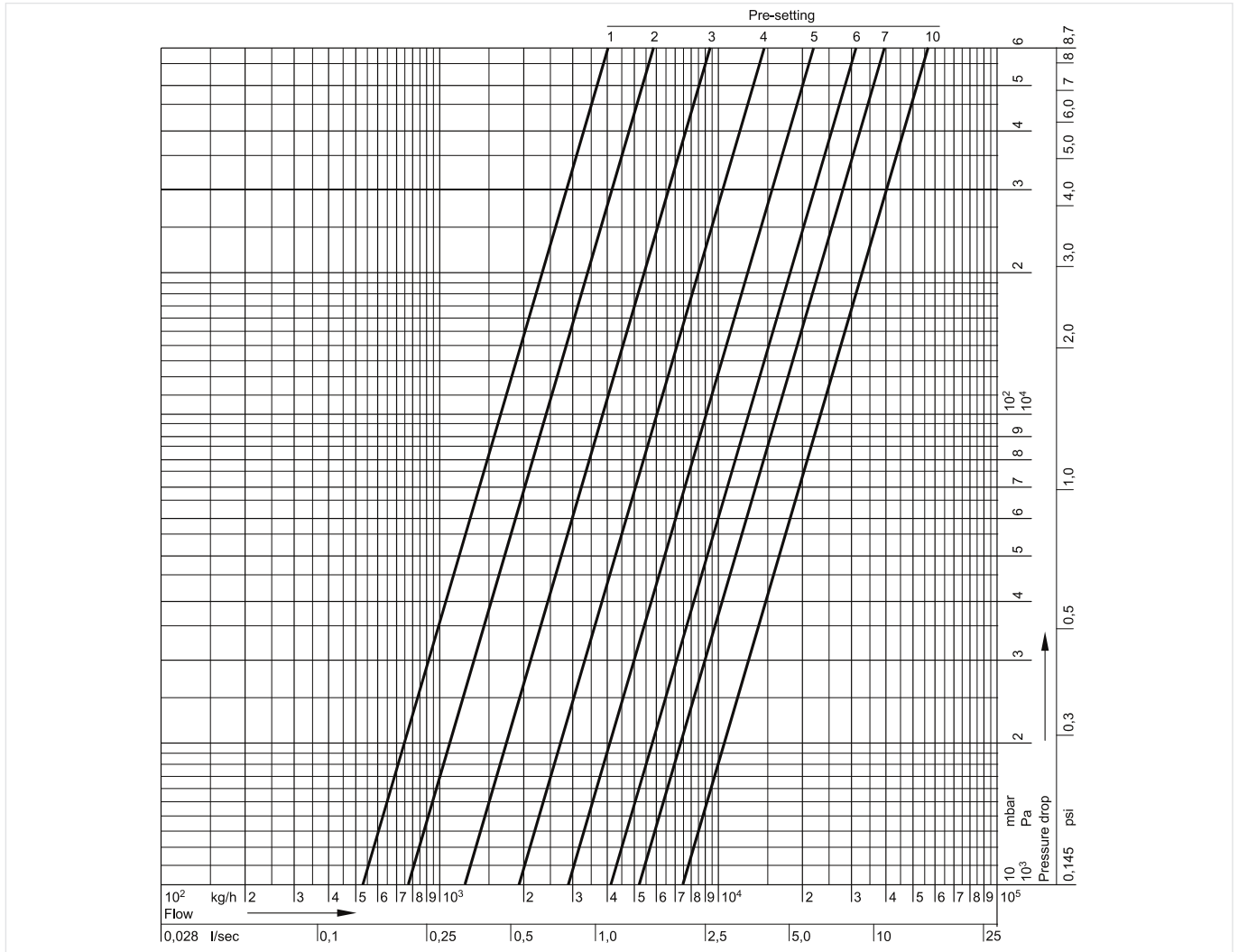

kvs-Values Kombi-F-II, DN80

Presetting:	0.5	1.0	1.5	2.0	2.5	3.0	3.5	4.0	4.5	5.0	5.5	6.0	6.5	7.0	7.5	8.0	8.5
k _v -value:	3.65	6.60	8.52	10.0	11.7	13.7	16.1	19.2	23.2	28.1	33.9	40.4	47.7	55.4	63.2	70.9	78.1
cv-value:	4.27	7.72	9.97	11.7	13.7	16.0	18.8	22.5	27.1	32.9	39.42	47.3	55.47	64.8	73.49	83.0	90.81

Presetting:	9.0	9.5	10.0	10.5	11.0	12.0 = open
k _v -value:	84.8	90.8	96.1	100.5	104.3	k _{vs} = 111
cv-value:	99.2	105.6	112	116.9	121.3	130

Flow Data Kombi-F-II, DN80

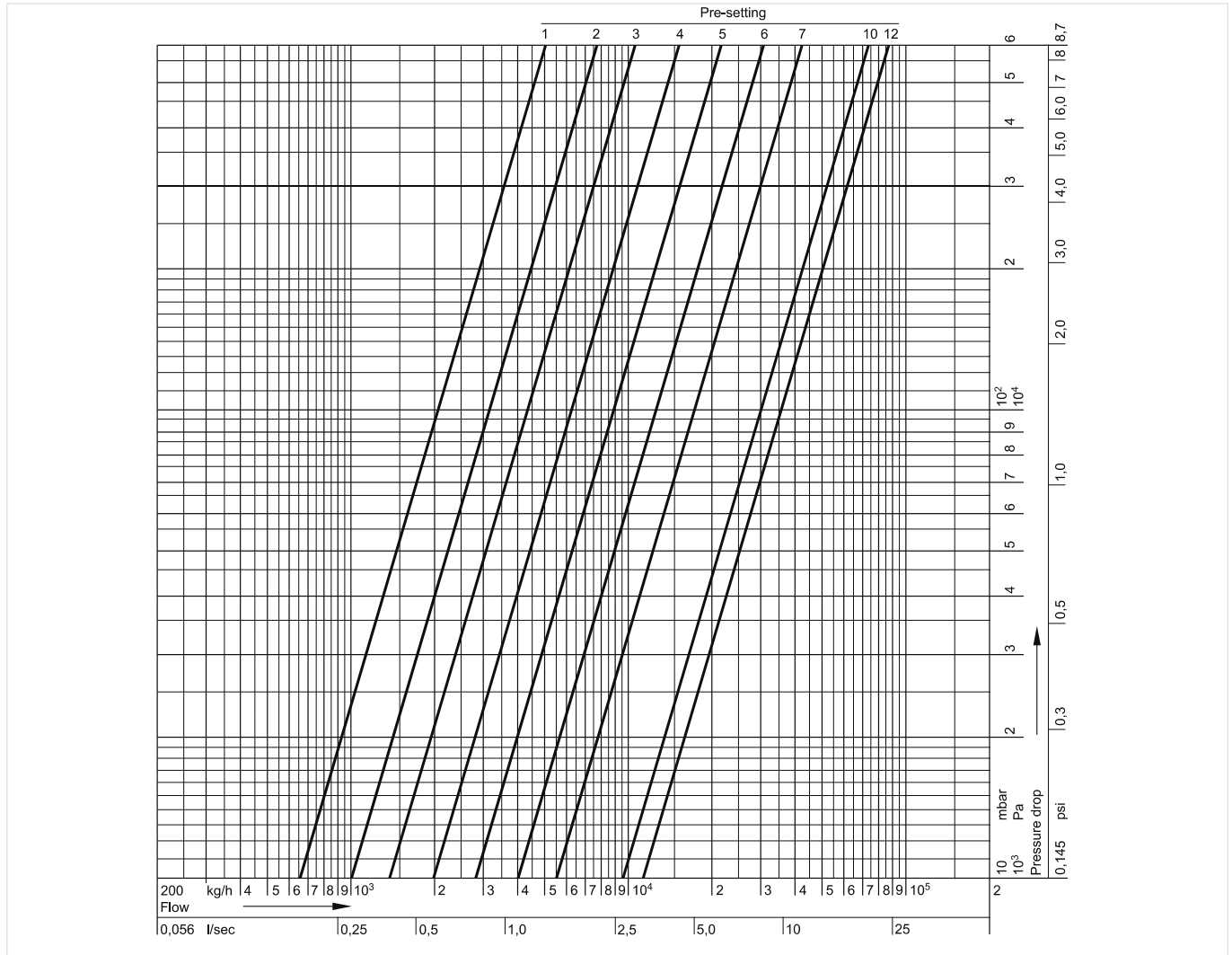

kvs-Values Kombi-F-II, DN100

Presetting:	1.5	2.0	2.5	3.0	3.5	4.0	4.5	5.0	5.5	6.0	6.5	7.0	7.5	8.0	8.5
k _v -value:	3.89	6.22	9.60	13.4	17.3	21.8	27.6	35.7	47.2	62.4	79.3	96.6	110	121	130
cv-value:	4.52	7.23	11.2	15.7	20.2	25.5	32.3	41.8	55.2	73.0	92.8	113	129	142	151.2

Presetting:	9.0	9.5	10.0	10.5	11.0	12.0 = open
k _v -value:	137	143	148.4	153	157	k _{vs} = 165
cv-value:	160	160	172.6	177.9	184	193

Flow Data Kombi-F-II, DN100

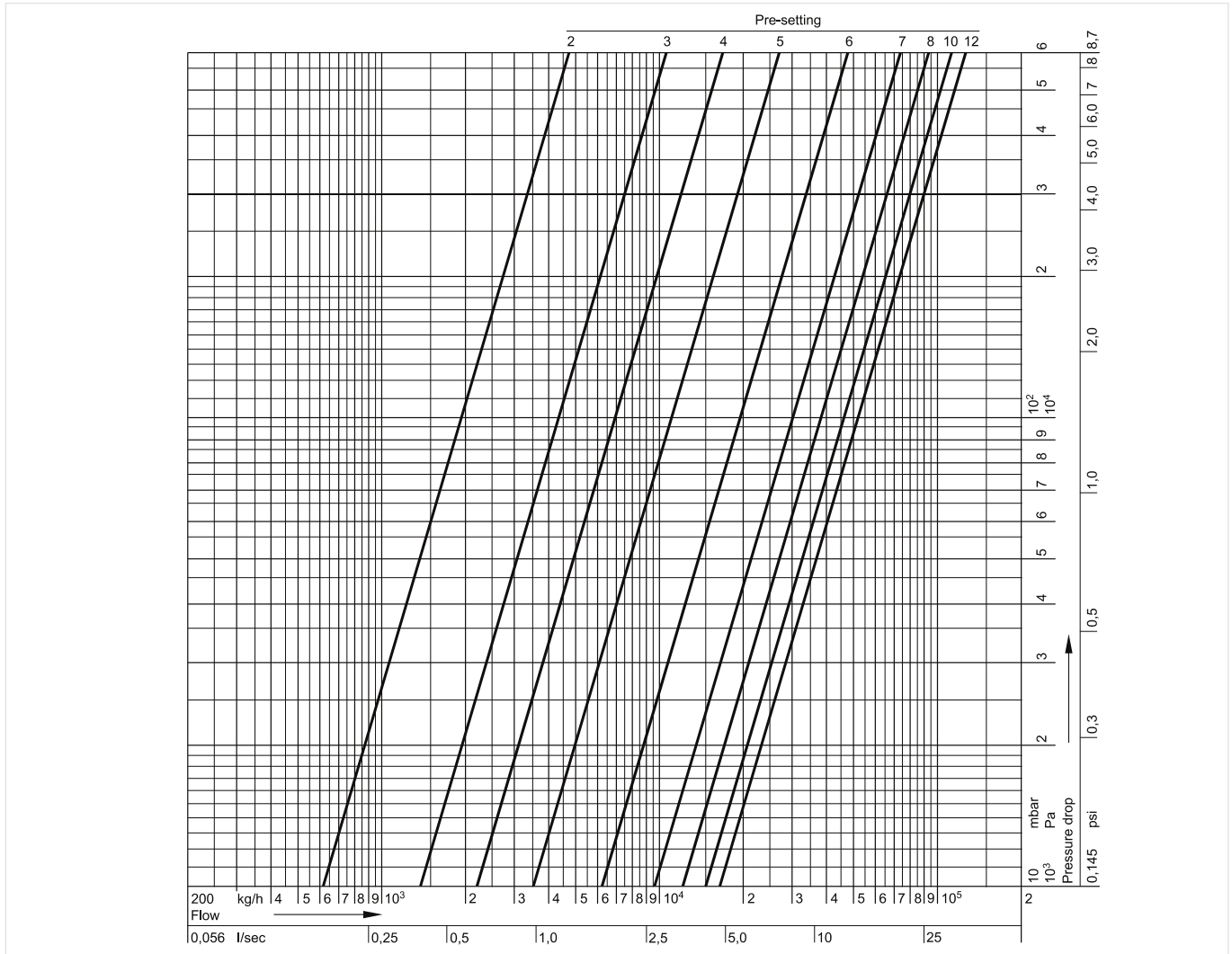

kvs-Values Kombi-F-II, DN125

Presetting:	1.5	2.0	2.5	3.0	3.5	4.0	4.5	5.0	5.5	6.0	6.5	7.0	7.5	8.0	8.5
k _v -value:	8.30	11.3	14.4	17.7	21.1	24.6	28.2	32.3	37.4	44.9	56.1	72.5	93.2	119.6	142
cv-value:	9.71	13.2	16.8	20.7	24.7	28.8	33.0	37.8	43.8	52.5	65.6	84.8	109	139	165

Presetting:	9.0	9.5	10.0	10.5	11.0	11.5	12.0	12.5	13.0	13.5 = open
k _v -value:	162	179	192	202	211	218	225	231	236	k _{vS} = 242
cv-value:	190	208	225	235	247	253	263	269	276	281

Flow Data Kombi-F-II, DN125

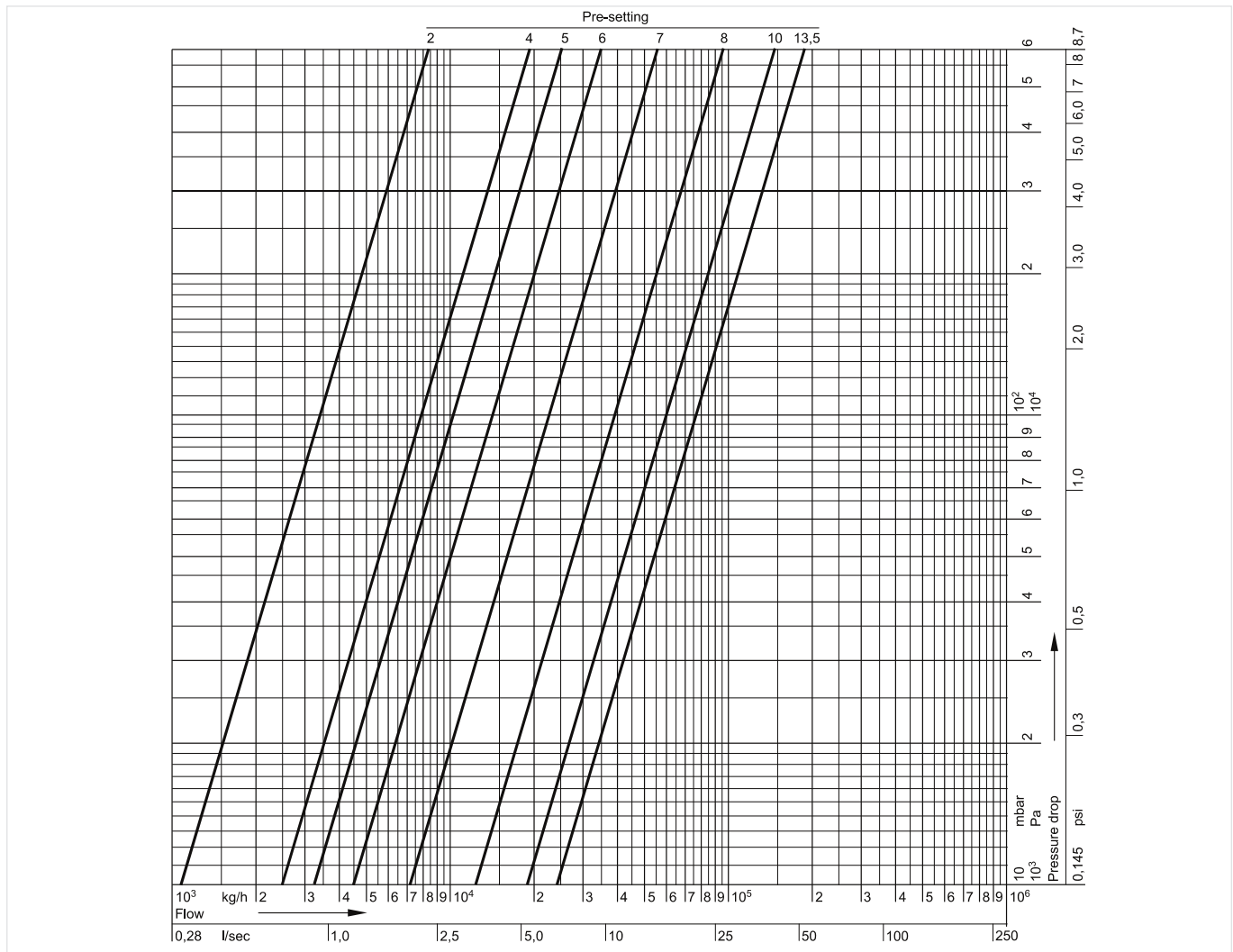

kvs-Values Kombi-F-II, DN150

Presetting:	1.5	2.0	2.5	3.0	3.5	4.0	4.5	5.0	5.5	6.0	6.5	7.0	7.5	8.0	8.5	9.0	9.5
k _v -value:	16.2	20.4	23.8	26.7	29.5	33.0	37.6	42.3	48.0	54.5	61.5	69.6	80.0	92.9	111	136	164
cv-value:	19.0	23.9	27.8	31.2	34.5	38.6	44.0	49.5	56.2	63.8	72.0	81.4	93.6	109	129	159	191

Presetting:	10.0	10.5	11.0	11.5	12.0	12.5	13.0	13.5	14.0	14.5	15.0	15.5	16.0	16.5	17.0	17.5 = open
k _v -value:	193	218	240	258	274	288	300	310	320	329	337	345	352	359	365	k _{vs} = 372
cv-value:	226	253	281	300	321	335	351	360	374	383	394	401	412	417	427	435

Flow Data Kombi-F-II, DN150

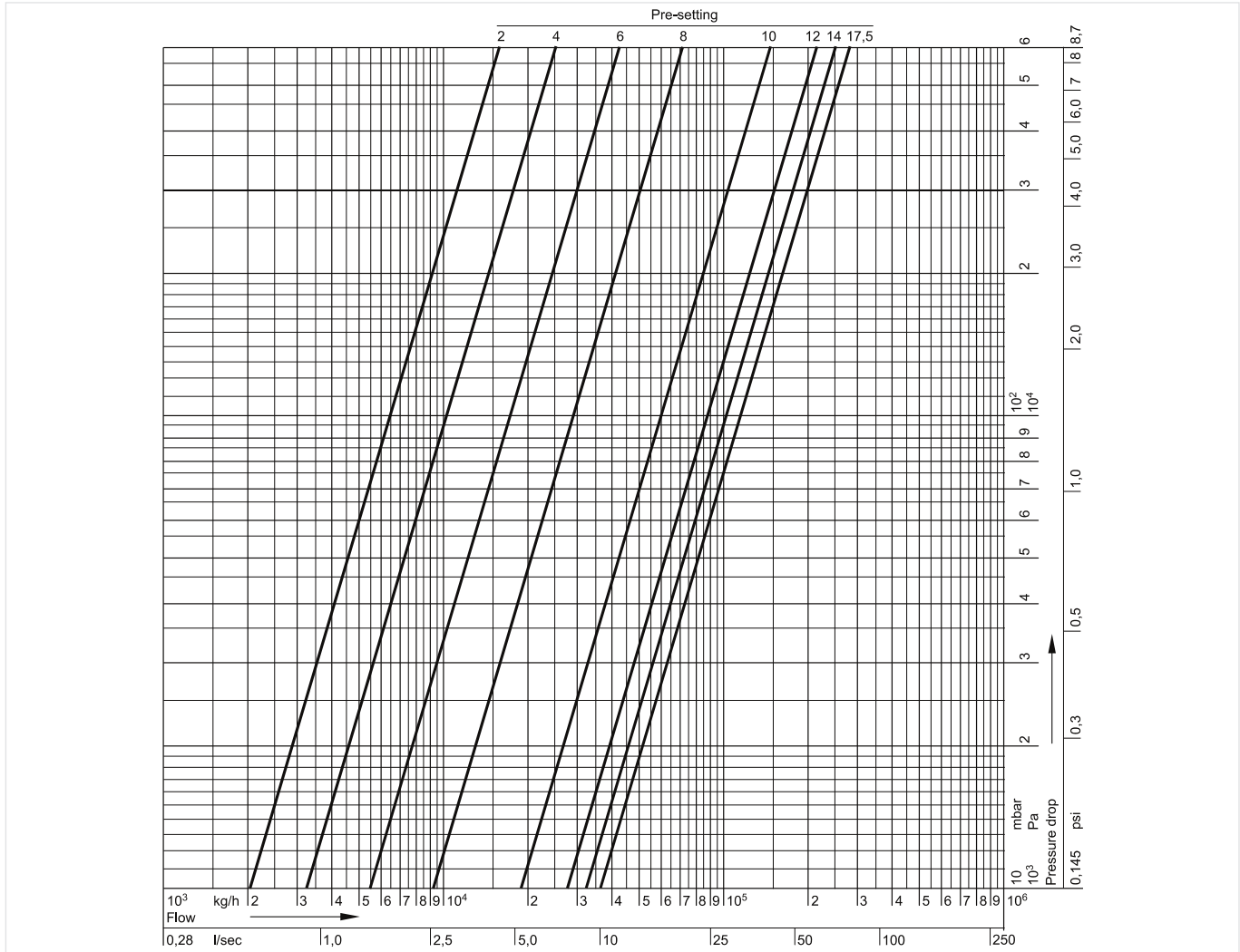

kvs-Values Kombi-F-II, DN200

Pre-setting:	1.5	2.0	2.5	3.0	3.5	4.0	4.5	5.0	5.5	6.0	6.5	7.0	7.5	8.0	8.5	9.0	9.5	10.0
k _v -value:	32.5	41.3	48.9	55.5	62.1	69.0	77.8	88.1	101	115	133	154	179	208	244	284	325	364
cv-value:	38.0	48.3	57.2	64.9	72.7	80.2	91.0	103	118	135	156	180	209	243	284	332	378	426

Pre-setting:	10.5	11.0	11.5	12.0	12.5	13.0	13.5	14.0	14.5	15.0	15.5	16.0	16.5	17.0	17.5	18.0 = open
k _v -value:	402	435	464	489	515	537	558	575	595	613	630	646	661	677	692	k _{vs} = 704
cv-value:	467	509	540	572	599	628	649	673	692	717	733	756	769	792	805	824

Flow Data Kombi-F-II, DN200

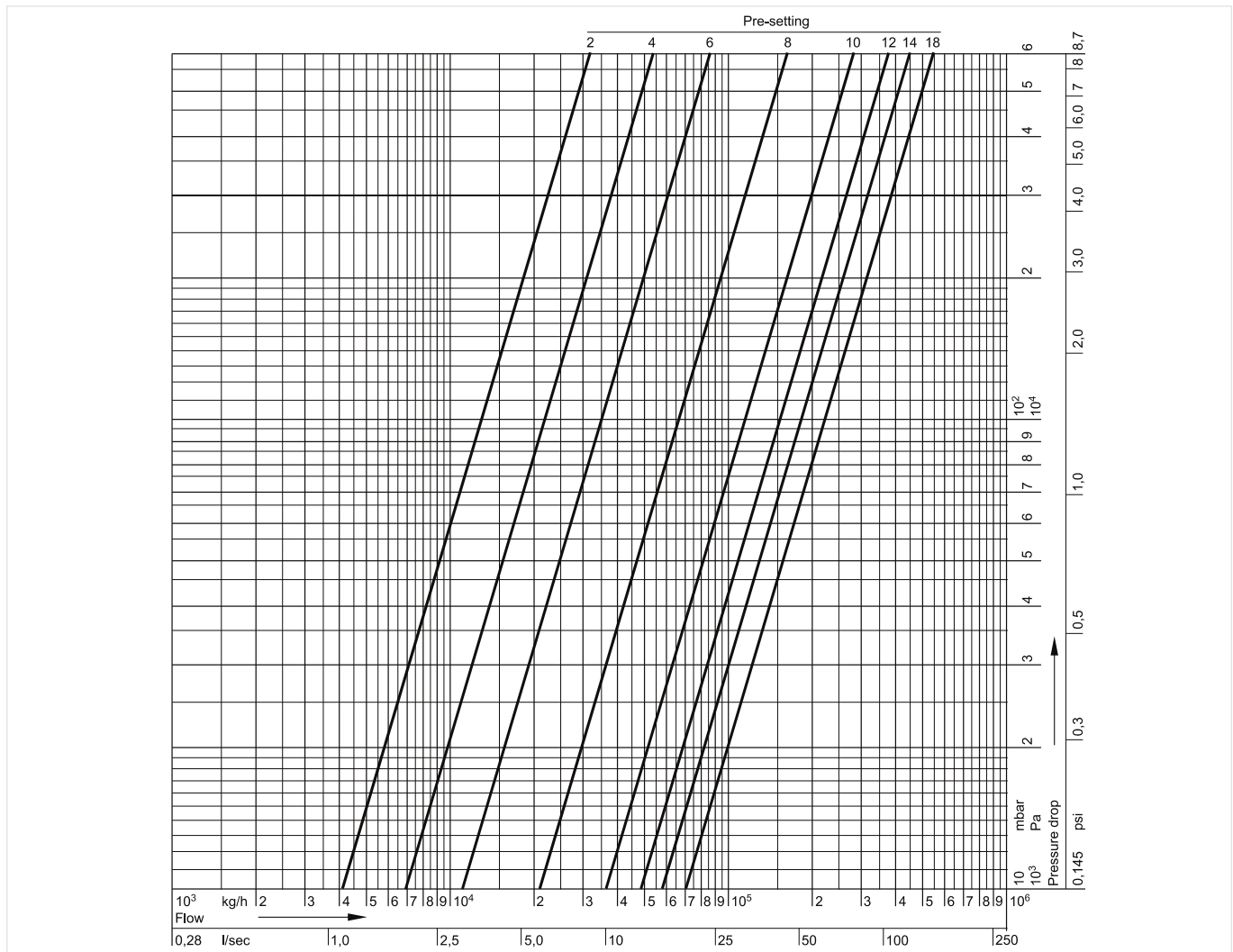

kvs-Values Kombi-F, DN250

Presetting:	1	2	3	4	5	6	7	8	9	11.0 = open
k _v -value:	66	179	297	410	514	587	662	731	775	k _{vs} = 812
c _v -value:	77	208	347	480	601	687	770	855	901	950

Flow Data Kombi-F, DN250

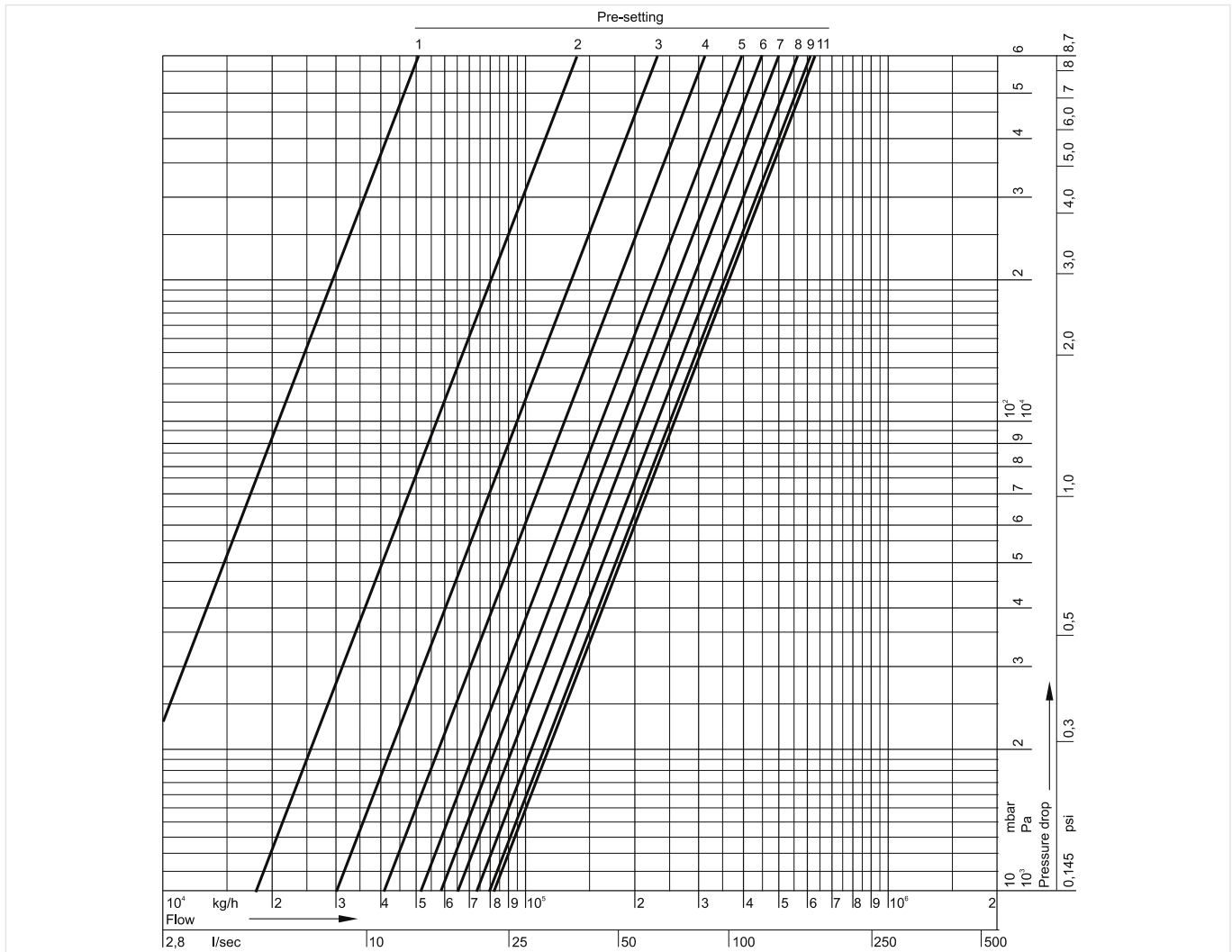

kvs-Values Kombi-F, DN300

Pre-setting:	1	2	3	4	5	6	7	8	9	10	11	12	13	14.0 = open
k _v -value:	n.a.	n.a.	411	560	696	825	940	1044	1142	1226	1287	1328	1357	k _{vS} = 1380
cv-value:	n.a.	n.a.	481	655	814	965	1093	1221	1329	1434	1497	1544	1578	1615

Flow Data Kombi-F, DN300

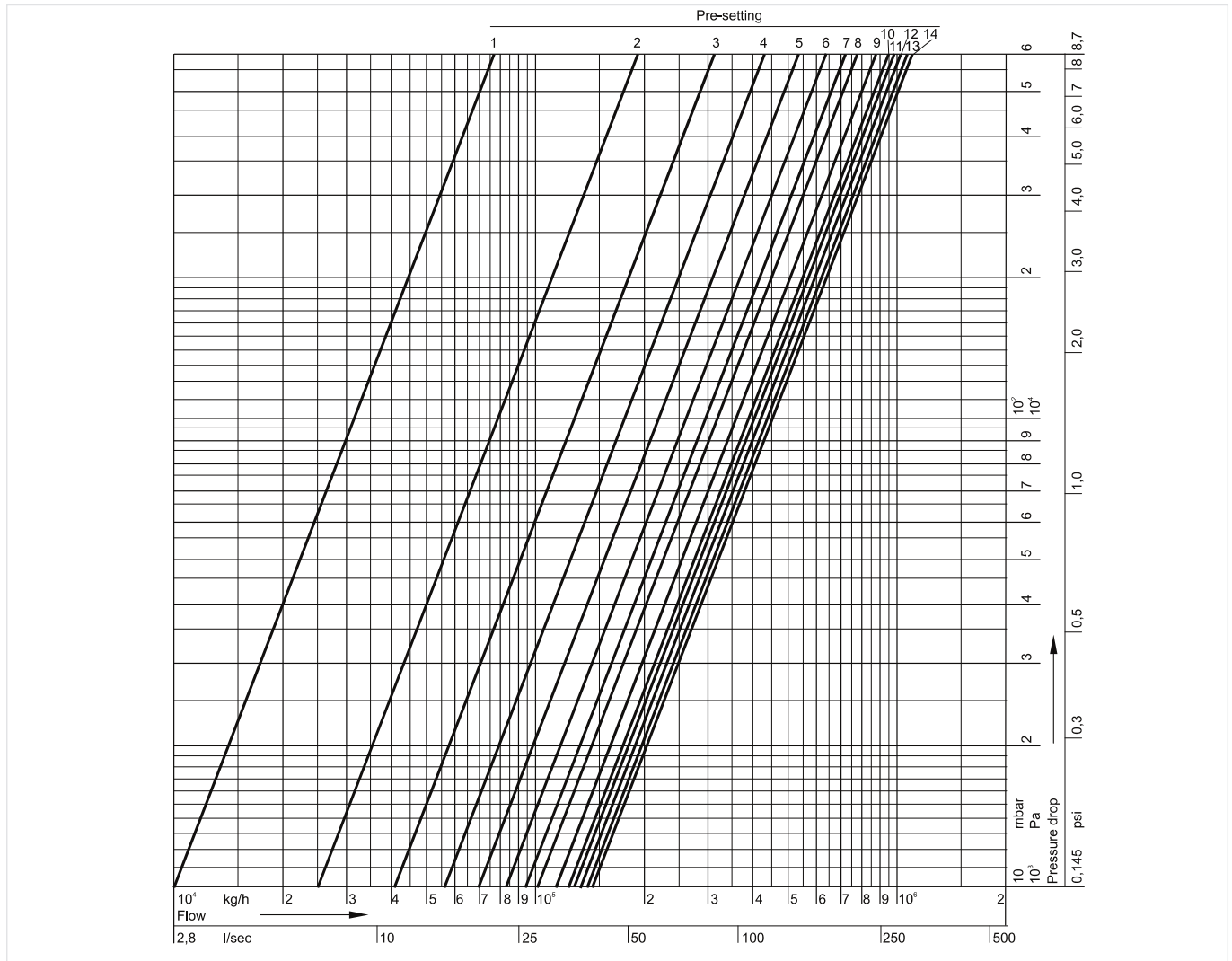

kvs-Values Kombi-F, DN350

Pre-setting:	1	2	3	4	5	6	7	8	9	10	11	12.0 = open
k _v -value:	n.a.	n.a.	495	675	851	1019	1153	1272	1399	1513	1593	k _{vS} = 1651
cv-value:	n.a.	n.a.	579	785	966	1192	1341	1488	1627	1770	1856	1932

Flow Data Kombi-F, DN350

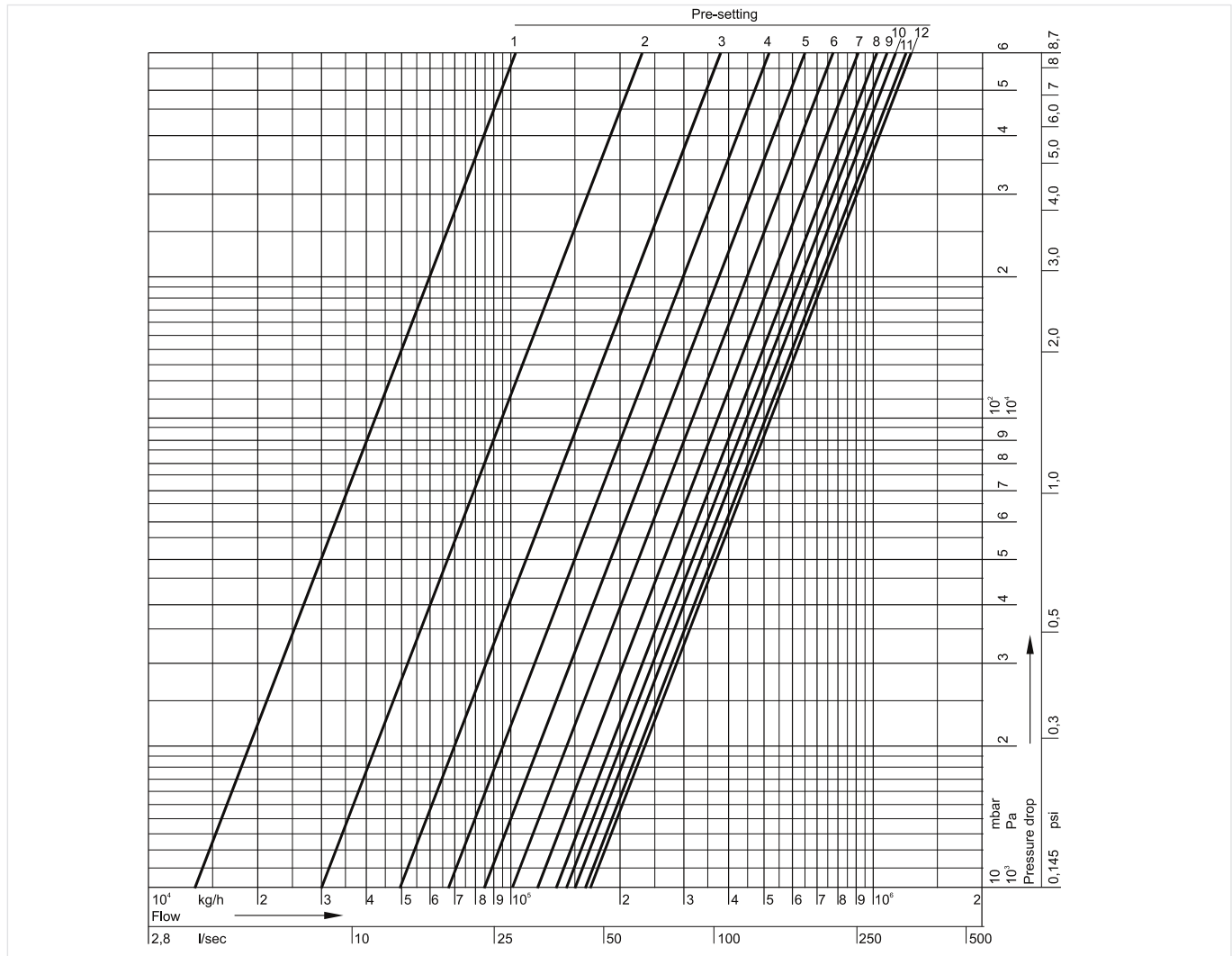

kvs-Values Kombi-F, DN400

Presetting:	1	2	3	4	5	6	7	8	9	10	11	12	13.0 = open
k _v -value:	n.a.	n.a.	690	938	1182	1409	1598	1752	1876	1991	2114	2246	k _{vS} = 2383
cv-value:	n.a.	n.a.	807	1091	1383	1649	1858	2050	2181	2329	2458	2612	2771

Flow Data Kombi-F, DN400

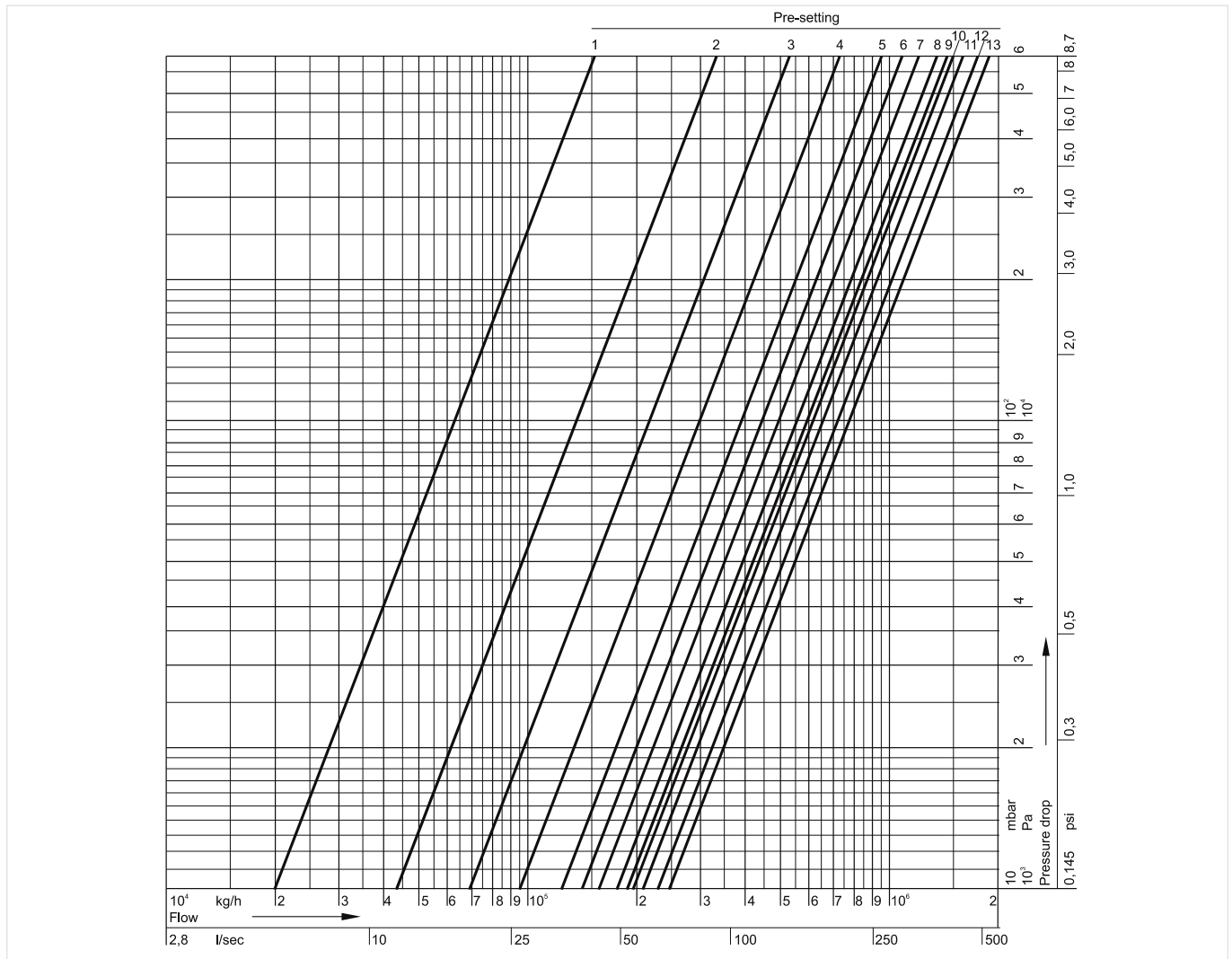

DIMENSIONS

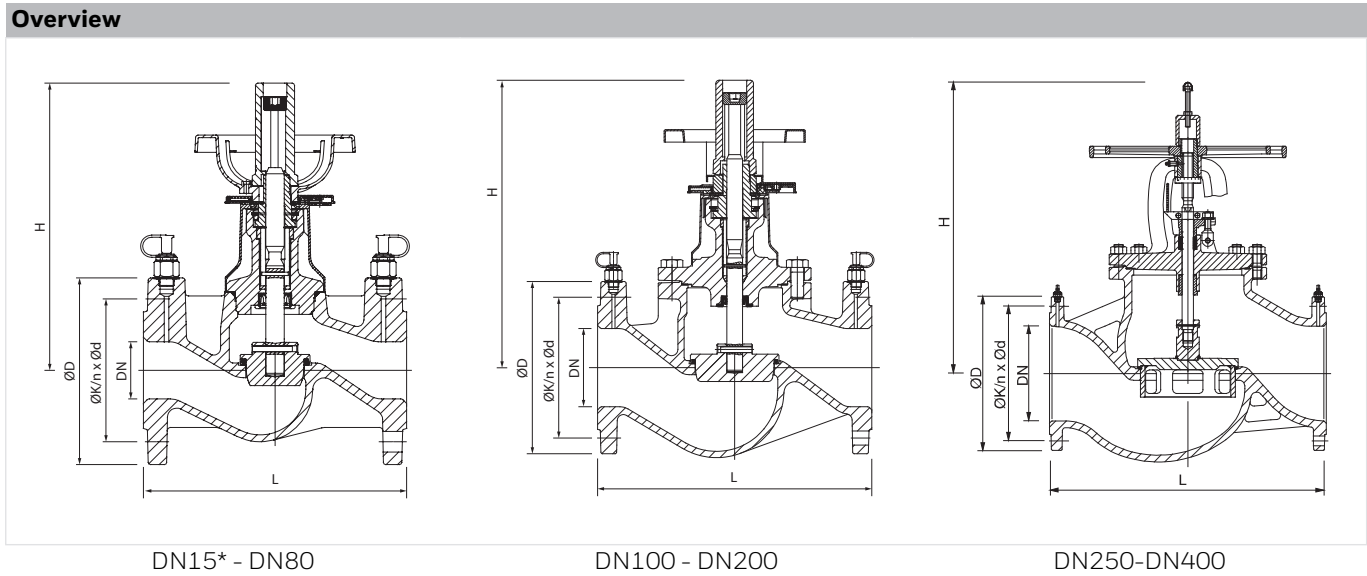

Kombi-F-II

DN	(R)	$k_{vs}(C_{vs})$ -value	L	H	Ø D	Ø K	n x Ø d	Weight	O.S. no.
15*	1/2"	4.5 (5.27)	130	215	95	65	4 x 14	3.5 kg	V6000D0015A
20*	3/4"	6.6 (7.72)	150	215	105	75	4 x 14	4.1 kg	V6000D0020A
25	1"	9.8 (11.5)	160	215	115	85	4 x 14	4.8 kg	V6000D0025A
32	1 1/4"	15.1 (17.7)	180	215	140	100	4 x 18	6.6 kg	V6000D0032A
40	1 1/2"	24.9 (29.1)	200	255	150	110	4 x 18	9.0 kg	V6000D0040A
50	2"	48.5 (56.7)	230	255	165	125	4 x 18	11.5 kg	V6000D0050A
65	2 1/2"	74.4 (87.0)	290	315	185	145	8 x 18	18.5 kg	V6000D0065A
80	3"	111 (130)	310	335	200	160	8 x 18	24.5 kg	V6000D0080A
100	4"	165 (193)	350	370	220	180	8 x 18	40.0 kg	V6000D0100A
125	5"	242 (283)	400	400	250	210	8 x 18	79.0 kg	V6000D0125A
150	6"	372 (435)	480	450	285	240	8 x 22	91.0 kg	V6000D0150A
200	7"	704 (824)	600	540	340	295	12 x 22	170 kg	V6000D0200A

Note: All dimensions in mm unless stated otherwise.

* DN15 and DN20 without pressure test cocks

Kombi-F

DN	(R)	$k_{vs}(C_{vs})$ -value	L	H	Ø D	Ø K	n x Ø d	Weight	O.S. no.
250	10"	812 (950)	730	785	405	355	12 x 26	265 kg	V6000D0250A
300	12"	1.380 (1.615)	850	890	460	410	12 x 26	360 kg	V6000D0300A
350	14"	1.651 (1.932)	980	1035	520	470	16 x 26	535 kg	V6000D0350A
400	16"	2.383 (2.771)	1.100	1050	580	525	16 x 30	765 kg	V6000D0400A

ORDERING INFORMATION

The following tables contain all the information you need to make an order of an item of your choice. When ordering, please always state the type, the ordering or the part number.

Accessories

	Description	Dimension	Part No.
	VA3600 Measuring adapter (2 pcs.)		
	For measuring computer VM241		VA3600C001
	VM242A BasicMes-2 handheld measuring computer		
	Note: To connect the VM241 BasicMes to SafeCon™ pressure test cocks please order measuring adapter VA3600C001 separately. Computer is supplied with case and accessories	for all sizes	VM242A0101
	VA2601 Extension piece for pressure test cocks, length 45 mm, for insulated valves		
		for all dimensions	VA2601A008
	101xxx Insulation shells		
		for valves DN65	101065
		for valves DN80	101080
		for valves DN100	101100
		for valves DN125	101125
		for valves DN150	101150
	VA5032A Draining adapter for SafeCon™ connections		
	Can be used to drain the water from a SafeCon connection provided on the balancing valve families as shown below	for all dimensions	VA5032A001

Spare Parts

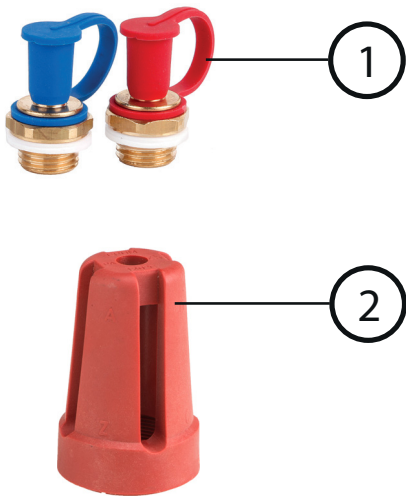
Overview	Description	Dimension	Part No.
 <p>The image shows two pressure test cocks, one with a blue handle and one with a red handle, both with brass fittings. Below them is a red, cone-shaped stroke indicator with a vertical slot. Circled numbers 1 and 2 point to the test cocks and the stroke indicator respectively.</p>	1 Spare set of 2 pressure test cocks G¹/₄"		
		DN10 - DN80	VS2600C001
	2 Red stroke indicator		
		DN15 - DN50	VS4600A015
		DN65 - DN125	VS4600A065
	DN150 - DN200	VS4600A200	



Manufactured for
and on behalf of
Pittway Sàrl, Z.A., La Pièce 4,
1180 Rolle, Switzerland
by its authorised representative
Ademco 1 GmbH

For more information
homecomfort.resideo.com/europe

Ademco 1 GmbH, Hardhofweg 40,
74821 MOSBACH, GERMANY

Phone: +49 6261 810
Fax: +49 6261 81309