

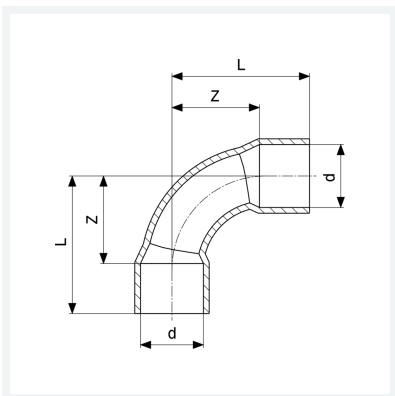

Curva a 90°
- estremità a saldare femmina
Modello 95002A

articolo 100 148



Caratteristiche

Marchio di qualità Cu	Cu	✓
Diametro esterno del tubo	d	18
Dimensione	Z	21 mm
Lunghezza	L	34 mm
Peso	28,8 g	
Volume	49,7 cm ³	
Materiale	rame	