

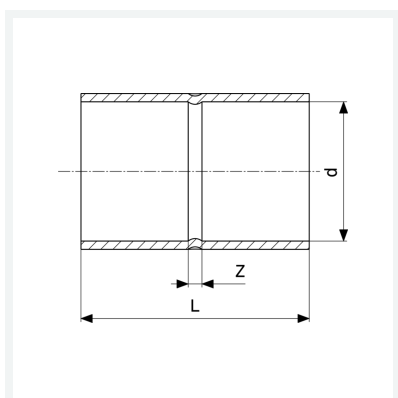

Manicotto con battente
- estremità a saldare femmina
Modello 95270

articolo 100 872



Caratteristiche

Marchio di qualità Cu	Cu	✓
Diametro esterno del tubo	d	12
Dimensione	Z	2 mm
Lunghezza	L	19 mm
Peso	4,8 g	
Volume	10,36 cm ³	
Materiale	rame	