

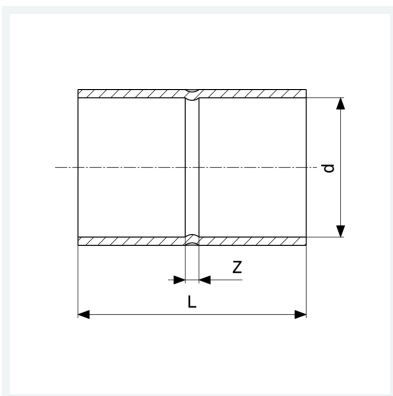

Manicotto con battente
- estremità a saldare femmina
Modello 95270

articolo 100 469



Caratteristiche

Marchio di qualità Cu	Cu	✓
Diametro esterno del tubo	d	18
Dimensione	Z	2 mm
Lunghezza	L	27 mm
Peso	12,6 g	
Volume	35,52 cm ³	
Materiale	rame	