

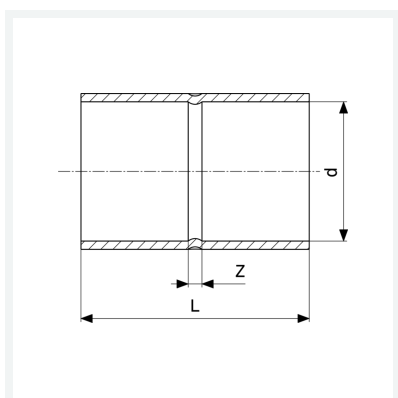

Manicotto con battente
- estremità a saldare femmina
Modello 95270

articolo 100 698



Caratteristiche

Marchio di qualità Cu	Cu	✓
Diametro esterno del tubo	d	28
Dimensione	Z	2 mm
Lunghezza	L	38 mm
Peso	33,7 g	
Volume	88,8 cm ³	
Materiale	rame	