

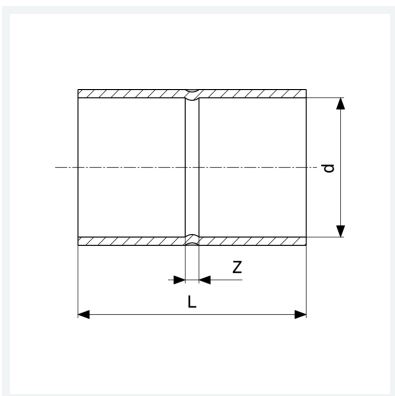

Manicotto con battente
- estremità a saldare femmina
Modello 95270

articolo 105 433



Caratteristiche

Marchio di qualità Cu	Cu	✓
Diametro esterno del tubo	d	42
Dimensione	Z	2 mm
Lunghezza	L	56 mm
Peso	85,3 g	
Volume	248,64 cm ³	
Materiale	rame	