

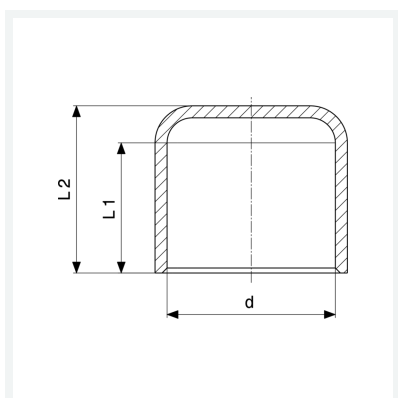

Cappuccio
- estremità a saldare femmina
Modello 95301

articolo 104 450



Caratteristiche

Diametro esterno del tubo	d	12
Lunghezza 1	L1	9 mm
Lunghezza 2	L2	11 mm
Peso	5,4 g	
Volume	7,77 cm ³	
Materiale	rame	