

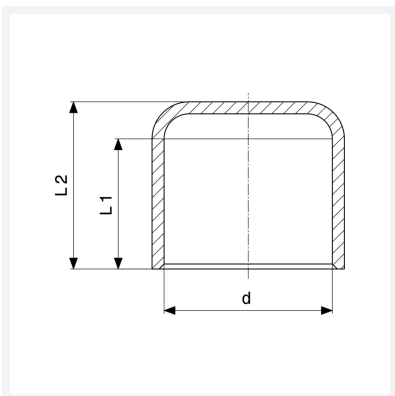

Cappuccio
- estremità a saldare femmina
Modello 95301

articolo 467 678



Caratteristiche

Diametro esterno del tubo	d	14
Lunghezza 1	L1	11 mm
Lunghezza 2	L2	13 mm
Peso	4,7 g	
Volume	12,43 cm ³	
Materiale	rame	