

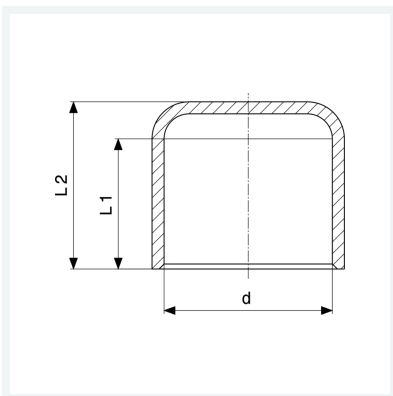

Cappuccio
- estremità a saldare femmina
Modello 95301

articolo 109 134



Caratteristiche

Diametro esterno del tubo	d	35
Lunghezza 1	L1	25 mm
Lunghezza 2	L2	29 mm
Peso	49,2 g	
Volume	82,88 cm ³	
Materiale	rame	