

**Manicotto**

- estremità a saldare femmina, filettatura R

Fornitura

Per chiave esagonale

Modello 94243G

articolo 467 746

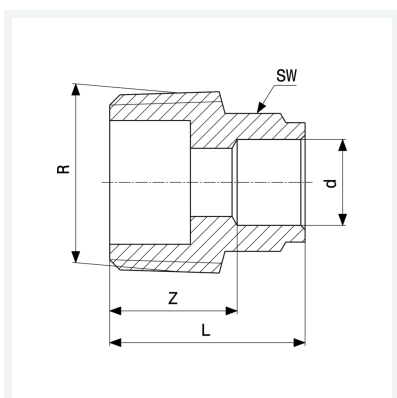

Caratteristiche

Diametro esterno del tubo	d	14
Filettatura maschio conica	R	$\frac{3}{8}$
Dimensione	Z	14 mm
Lunghezza	L	25 mm
Diametro chiave	SW	18 mm
Peso	21,44 g	
Volume	24,86 cm ³	
Materiale	bronzo	