

**Manicotto**

- estremità a saldare femmina, filettatura R

**Fornitura**

Per chiave esagonale

**Modello 94243G**

**articolo 101 039**

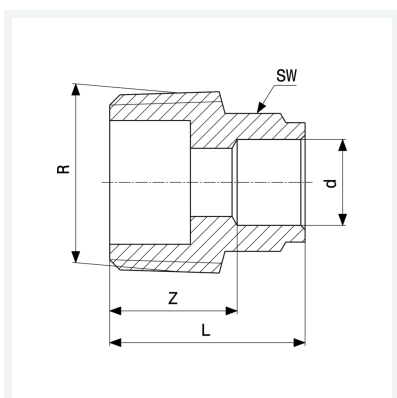

## Caratteristiche

Diametro esterno del tubo	d	18
Filettatura maschio conica	R	¾
Dimensione	Z	13 mm
Lunghezza	L	26 mm
Diametro chiave	SW	21 mm
Peso	36,1 g	
Volume	35,52 cm <sup>3</sup>	
Materiale	bronzo	