

**Manicotto**

- estremità a saldare femmina, filettatura R

Fornitura

Per chiave esagonale

Modello 94243G

articolo 109 196

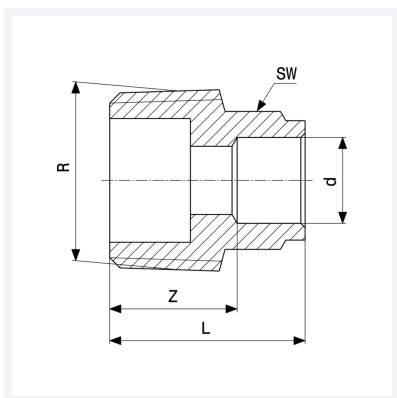

Caratteristiche

Diametro esterno del tubo	d	54
Filettatura maschio conica	R	2
Dimensione	Z	30 mm
Lunghezza	L	62 mm
Diametro chiave	SW	61 mm
Peso	360,24 g	
Volume	497,28 cm ³	
Materiale	bronzo	