

**Manicotto**

- estremità a saldare femmina, filettatura Rp

Fornitura

Per chiave esagonale

Modello 94270G

articolo 119 515

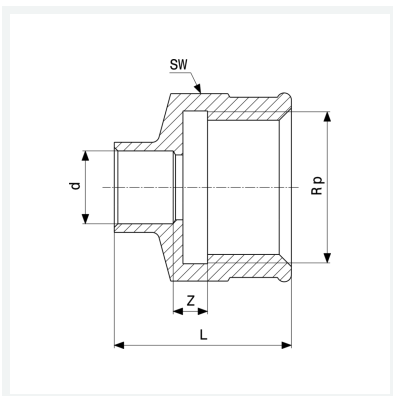

Caratteristiche

Diametro esterno del tubo	d	10
Filettatura interna cilindrica	Rp	½
Dimensione	Z	1 mm
Lunghezza	L	25 mm
Diametro chiave	SW	25 mm
Peso	36,3 g	
Volume	35,52 cm ³	
Materiale	bronzo	