

**Manicotto**

- estremità a saldare femmina, filettatura Rp

Fornitura

Per chiave esagonale

Modello 94270G

articolo 475 765

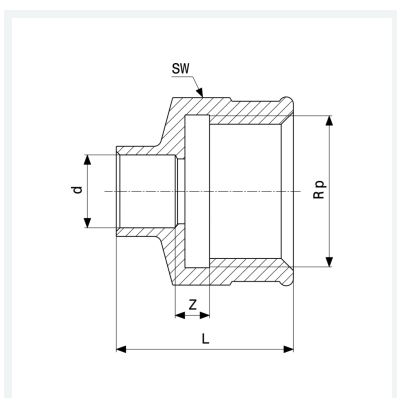

Caratteristiche

Diametro esterno del tubo	d	16
Filettatura interna cilindrica	Rp	½
Dimensione	Z	2 mm
Lunghezza	L	28 mm
Diametro chiave	SW	25 mm
Peso	37,5 g	
Volume	35,52 cm ³	
Materiale	bronzo	