

**Manicotto**

- estremità a saldare femmina, filettatura Rp

Fornitura

Per chiave esagonale

Modello 94270G

articolo 102 470

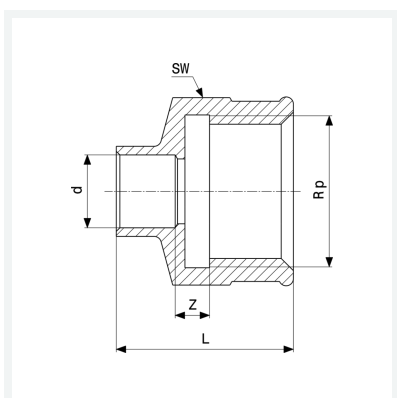

Caratteristiche

Diametro esterno del tubo	d	22
Filettatura interna cilindrica	Rp	1
Dimensione	Z	1 mm
Lunghezza	L	36 mm
Diametro chiave	SW	38 mm
Peso	93,74 g	
Volume	103,6 cm ³	
Materiale	bronzo	