

**Manicotto**

- estremità a saldare femmina, filettatura Rp

Fornitura

Per chiave esagonale

Modello 94270G

articolo 104 139

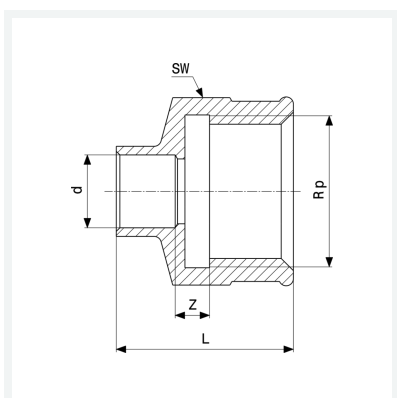

Caratteristiche

Diametro esterno del tubo	d	28
Filettatura interna cilindrica	Rp	¾
Dimensione	Z	2 mm
Lunghezza	L	37 mm
Diametro chiave	SW	30 mm
Peso	60,8 g	
Volume	62,16 cm ³	
Materiale	bronzo	