

**Manicotto**

- estremità a saldare femmina, filettatura Rp

Fornitura

Per chiave esagonale

Modello 94270G

articolo 100 964

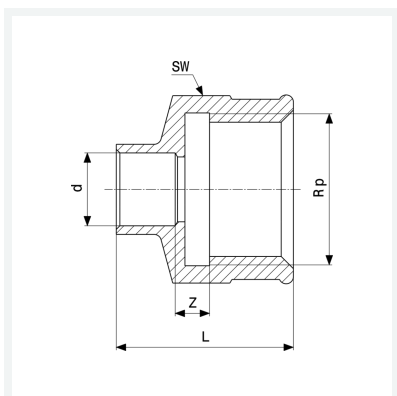

Caratteristiche

Diametro esterno del tubo	d	28
Filettatura interna cilindrica	Rp	1
Dimensione	Z	2 mm
Lunghezza	L	40 mm
Diametro chiave	SW	38 mm
Peso	91,508 g	
Volume	124,3 cm ³	
Materiale	bronzo	