

**Manicotto**

- estremità a saldare femmina, filettatura Rp

Fornitura

Per chiave esagonale

Modello 94270G

articolo 107 857

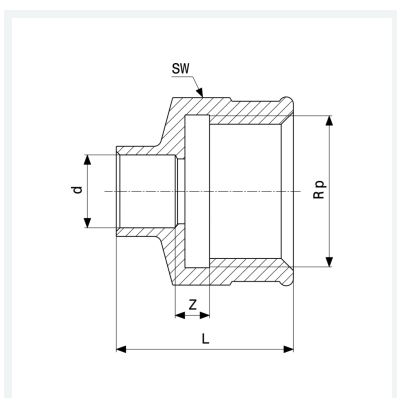

Caratteristiche

Diametro esterno del tubo	d	35
Filettatura interna cilindrica	Rp	1
Dimensione	Z	1 mm
Lunghezza	L	43 mm
Diametro chiave	SW	40 mm
Peso	99,5 g	
Volume	124,32 cm ³	
Materiale	bronzo	