



Gomito a 90°

- estremità a saldare femmina, filettatura Rp

Modello 94090G

articolo 467 708

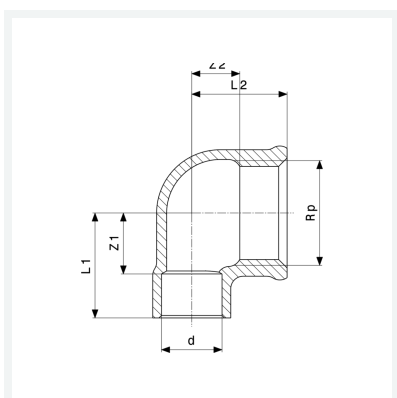

Caratteristiche

Diametro esterno del tubo	d	16
Filettatura interna cilindrica	Rp	½
Dimensione 1	Z1	13 mm
Dimensione 2	Z2	12 mm
Lunghezza 1	L1	24 mm
Lunghezza 2	L2	22 mm
Peso	55,9 g	
Volume	82,88 cm ³	
Materiale	bronzo	