



**Prolunga**  
- filettatura R, filettatura Rp

**Fornitura**  
Poligono interno

**Modello 3525**

**articolo 354 930**

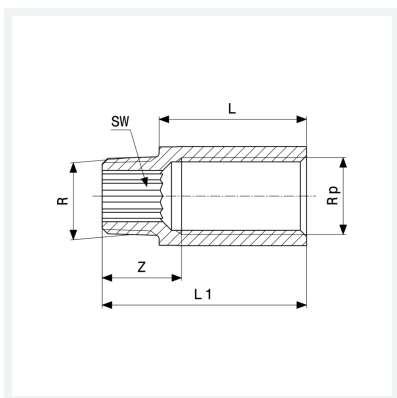

## Caratteristiche

Filettatura maschio conica	R	$\frac{3}{8}$
Filettatura interna cilindrica	Rp	$\frac{3}{8}$
Lunghezza	L	20
Dimensione	Z	18 mm
Lunghezza 1	L1	32 mm
Diametro chiave	SW	10 mm
Peso	46,4 g	
Volume	31,08 cm <sup>3</sup>	
Materiale	bronzo o bronzo al silicio	