



**Prolunga**  
- filettatura R, filettatura Rp

**Fornitura**  
Poligono interno

**Modello 3525**

**articolo 355 005**

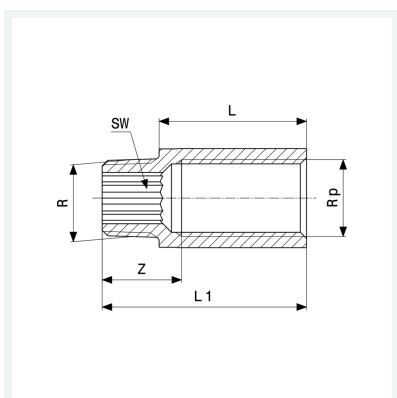

## Caratteristiche

Filettatura maschio conica	R	1/2
Filettatura interna cilindrica	Rp	1/2
Lunghezza	L	40
Dimensione	Z	22 mm
Lunghezza 1	L1	56 mm
Diametro chiave	SW	12 mm
Peso	123,15 g	
Volume	82,88 cm <sup>3</sup>	
Materiale	bronzo o bronzo al silicio	