



**Prolunga**  
- filettatura R, filettatura Rp

**Fornitura**  
Poligono interno

**Modello 3525**

**articolo 355 036**

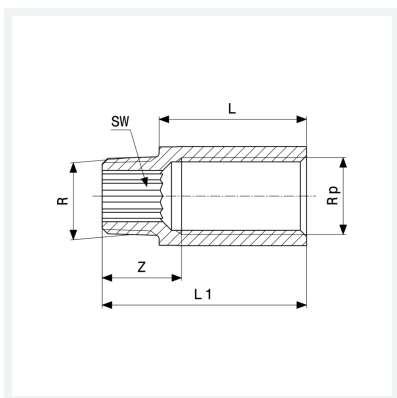

## Caratteristiche

Filettatura maschio conica	R	$\frac{3}{4}$
Filettatura interna cilindrica	Rp	$\frac{3}{4}$
Lunghezza	L	25
Dimensione	Z	26 mm
Lunghezza 1	L1	42 mm
Diametro chiave	SW	17 mm
Peso	108,2 g	
Volume	82,88 cm <sup>3</sup>	
Materiale	bronzo o bronzo al silicio	