



**Curva a 90° Profipress G
con SC-Contur**

- estremità a pressare femmina

Fornitura

O-ring HNBR

Modello 2616

articolo 345 464

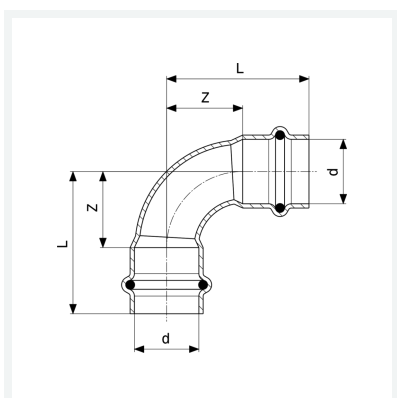

Caratteristiche

Diametro esterno del tubo	d	15
Dimensione	Z	16 mm
Lunghezza	L	38 mm
Dimensione (versione precedente)	Z*	18 mm
Lunghezza (versione precedente)	L*	40 mm
Peso	46,1 g	
Volume	82,88 cm ³	
Materiale	rame	