

**Curva a 45° Profipress G
con SC-Contur**

- estremità a pressare femmina

Fornitura

O-ring HNBR

Modello 2626

articolo 345 600

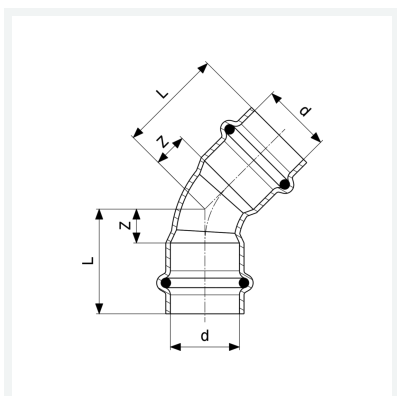

Caratteristiche

Diametro esterno del tubo	d	15
Dimensione	Z	7 mm
Lunghezza	L	29 mm
Dimensione (versione precedente)	Z*	8 mm
Lunghezza (versione precedente)	L*	30 mm
Peso	40,9 g	
Volume	82,88 cm ³	
Materiale	rame	