



Manicotto Profipress G con SC-Contur

- estremità a pressare femmina, filettatura Rp

Fornitura

O-ring HNBR, per chiave esagonale

Modello 2612

articolo 346 393

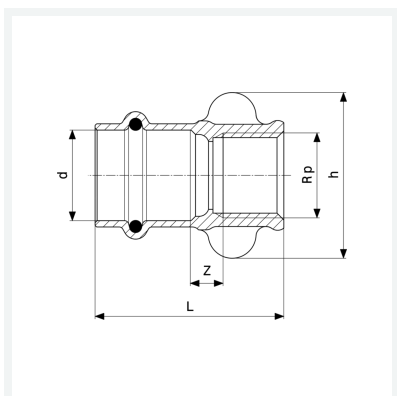

Caratteristiche

Diametro esterno del tubo	d	18
Filettatura interna cilindrica	Rp	½
Dimensione	Z	7 mm
Lunghezza	L	43 mm
Diametro chiave	SW	26 mm
Peso	65,6 g	
Volume	82,88 cm ³	
Materiale	bronzo	